



**GYPROCK<sup>®</sup>**

# StrataWall

DESIGN & INSTALLATION GUIDE

[Gyprock.com.au](http://Gyprock.com.au)

**CSR**

# Contents

Introduction	2
Applications	2
Advantages	3
Gyprock Plasterboard Selection	4
Components	6
Design Considerations	9
StrataWall Overview	13
Typical Installation Sequence	14
Typical Construction Details	15
Penetration Details	21
External Junction Details	25
StrataWall Installation Checklist	27
Health & Safety	28
Warranty	28
Contact Details	28

## Introduction

The CSR Gyprock StrataWall™ Systems (“StrataWall”) are designed to provide separating non-loadbearing walls between apartments in high rise buildings.

StrataWall is a range of systems characterised by a fire barrier between the finishing linings. To accommodate services, cavities are formed by separate framing on both sides to which the finishing linings are fixed. The fire barrier allows the finishing linings to be installed as per normal decorative linings, and to incorporate services and penetrations.

The basis of the fire resistance performance is a system consisting of the fire barrier (i.e., StrataWall central wall of one layer of 25mm Gyprock Shaft Liner MP (“Shaft Liner MP”) between purpose designed H-Studs) and the finishing linings. The H-Studs are installed into a top J-Track Extended Leg and screw fixed to a base Steel Angle. This allows the Shaft Liner panels to be installed rapidly and with little lifting.

The basis of the acoustic performance is the insulated double cavity. This provides discontinuous construction for impact isolation.

Additional systems are available for:

- Higher acoustic performance.
- Security rating.
- Impact damage rating.

## Applications

StrataWall is designed as non-loadbearing separating walls for Class 2 & 3 buildings of loadbearing concrete construction. StrataWall is not applicable for top floor applications under light framed roof structures, it is essential to seek independent project fire engineering and BCA advice where compliance would need to be achieved via a BCA permissible performance solution pathway. Systems are available with FRL –/60/60 and sound insulation ratings to meet NCC requirements.

Systems for other classes of buildings, and for other Fire Resistance Level (FRL) ratings are also available.

For further information visit [www.gyprock.com.au](http://www.gyprock.com.au) or call DesignLink on 1800 621 117.

# Advantages

- Steel frame options.
  - Systems for  $R_w + C_{tr} \geq 50\text{dB}$  and discontinuous construction.
  - Room linings installed as for non-rated systems.
  - No setting joints of central fire barrier.
  - Shaft Liner MP suitable for mould resistance during construction.
  - Heights up to 3.3m\*
  - Services simply incorporated.
  - Minimal use of sealants.
  - Plasterboard options for wet areas.
  - Rapid installation.
  - No additional trades.
- \*Maximum design ultimate pressure capacity of 0.348kPa.

Figure 1: StrataWall Overview

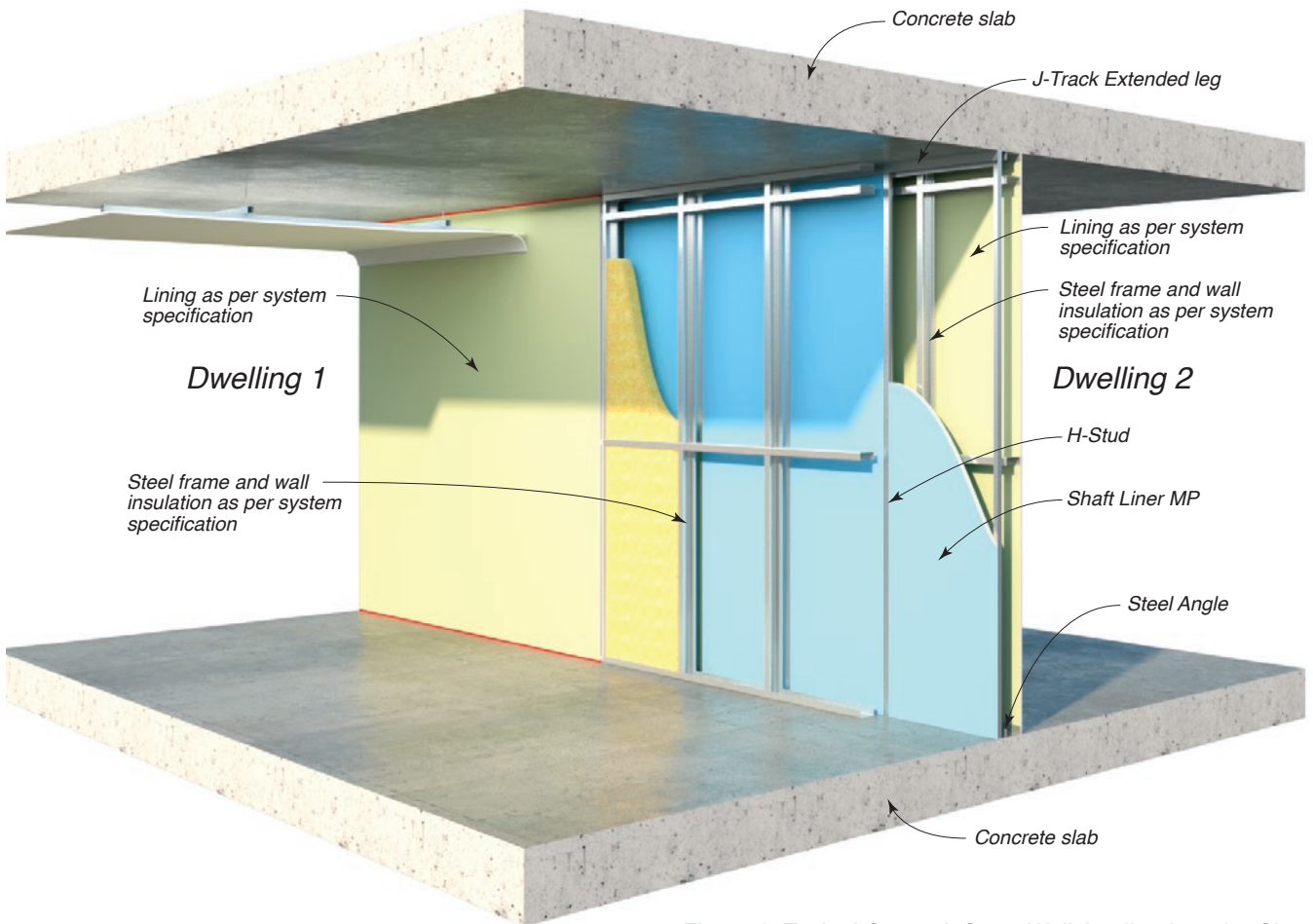
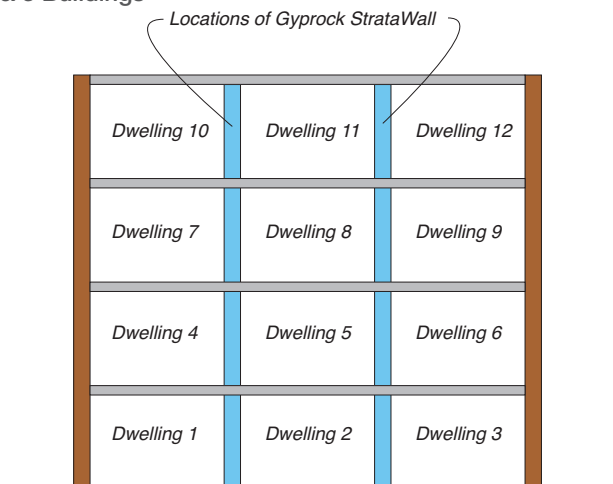











Figure 2: Typical Gyprock StrataWall Applications for Class 2 & 3 Buildings









# Gyprock Plasterboard Selection

Gyprock plasterboard products are available in a large range of sheet lengths. Lengths vary by state, and a full list is available at [www.gyprock.com.au](http://www.gyprock.com.au). Standard width is 1200mm. Some products are also available in 900, 1350 and 1400mm widths (lead times may apply). 25mm Gyprock Shaft Liner MP is supplied in 600mm width only. Colour shading behind each product name approximates the colour of the product face liner sheet.

Table 1: Gyprock Plasterboard Features, Applications & Specifications										
GYPROCK® PLASTERBOARDS	APPLICATIONS – WALLS & CEILINGS	THICK- NESS (mm)	MASS kg/m <sup>2</sup>	FIRE GRADE	MOISTURE RESISTANT	ENHANCED IMPACT RESISTANCE	ENHANCED SOUND RESISTANCE	MOULD RESISTANT	LOW VOC	GECA ACCREDITED
	FEATURES									
<b>COMMERCIAL – SELECT RANGE</b>										
<b>Standard Plasterboard</b>	RE – Recessed Edge <ul style="list-style-type: none"> <li>Long edges are recessed to assist in producing a smooth, even and continuous surface once jointed.</li> </ul>	13	8.5						✓	
	RE/SE – 1 Recessed Edge, 1 Square Edge <ul style="list-style-type: none"> <li>Typically used on walls with a single horizontal joint. One long edge is recessed to assist in producing a smooth, even and continuous surface once jointed.</li> <li>One long edge is square to enable easy fixing of skirting and cornice at the top and bottom of walls.</li> </ul>	13	8.5					✓		
	SE – 2 Square Edges <ul style="list-style-type: none"> <li>Long edges are square, and can be butted together without jointing, or covered with aluminium, timber or vinyl mouldings.</li> </ul>	13	8.5					✓		
<b>Aquachek™</b>	<ul style="list-style-type: none"> <li>Both the core and linerboard facing are treated in manufacture to withstand the effects of moisture and high humidity.</li> <li>Recessed long edges allow flush jointing to other Recessed Edge plasterboard types.</li> </ul>	13	9.8		✓			✓		
<b>Soundchek™</b>	<ul style="list-style-type: none"> <li>Designed to provide enhanced acoustic resistance.</li> <li>A machine made sheet composed of a high density gypsum core encased in a heavy duty linerboard.</li> <li>Long edges are recessed for flush jointing.</li> </ul>	13	13.0				✓	✓		
<b>Impactchek™</b>	<ul style="list-style-type: none"> <li>Fire grade board reinforced with a woven fibreglass mesh to produce a high strength plasterboard which resists hard and soft body impact damage.</li> <li>Ideal for high traffic areas such as hallways, stairways, playrooms and garages.</li> <li>Long edges are recessed for flush jointing.</li> </ul>	13	10.5	✓		✓	✓	✓		
<b>Fyrchek™</b>	<ul style="list-style-type: none"> <li>Fire grade board composed of a specially processed glass fibre reinforced gypsum core encased in a heavy duty linerboard.</li> <li>Ideal for high performance fire and acoustic rated walls and ceilings.</li> <li>Long edges are recessed for flush jointing.</li> </ul>	13	10.8	✓		✓		✓		
		16	12.9							
<b>Fyrchek™ MR</b>	<ul style="list-style-type: none"> <li>Fire grade board with moisture resistant properties.</li> <li>Both the core and the liner board are treated in manufacture to withstand the effects of high humidity and moisture.</li> <li>Long edges are recessed for flush jointing.</li> </ul>	13	11.1	✓		✓		✓		
		16	13.3	✓	✓		✓		✓	

**Table 1: Gyprock Plasterboard Features, Applications & Specifications**

GYPROCK® PLASTERBOARDS	APPLICATIONS – WALLS & CEILINGS	THICK- NESS (mm)	MASS kg/m²	FIRE GRADE	MOISTURE RESISTANT	ENHANCED IMPACT RESISTANCE	ENHANCED SOUND RESISTANCE	MOULD RESISTANT	LOW VOC	GECA ACCREDITED
	FEATURES									
<b>COMMERCIAL – SPECIALTY OPTIONS</b>										
<b>EC08™ Complete</b>	<ul style="list-style-type: none"> <li>This product features higher levels of recycled content, making it a superior choice for Green Building projects.</li> <li>Gyprock EC08 Complete is an internal lining solution which integrates an efficient mould inhibitor, scuff resistance, soft and hard body impact resistance, moisture resistance, sound resistance and fire resistance into a low VOC plasterboard.</li> <li>Long edges are recessed for flush jointing.</li> </ul>	13	12.4	✓	✓	✓	✓	✓	✓	 
		16	14.8							
<b>EC08™ Extreme</b>	<ul style="list-style-type: none"> <li>This product features higher levels of recycled content, making it a superior choice for Green Building projects.</li> <li>Gyprock EC08 Extreme is a premium internal lining solution with a focus on superior impact resistance for hard &amp; soft body impact, and surface indentation. It also includes an efficient mould inhibitor, moisture resistance, sound resistance and fire resistance in a low VOC plasterboard to provide multifunction performance to a wide variety of commercial projects.</li> <li>Long edges are recessed for flush jointing.</li> </ul>	13	12.5	✓	✓	✓	✓	✓	✓	 
<b>Shaft Liner Panel MP</b>	<ul style="list-style-type: none"> <li>Fire grade board with antifungal additives to resist mould formation.</li> <li>A 25mm thick sheet composed of a glass fibre reinforced gypsum core encased in a heavy duty ivory linerboard.</li> <li>600mm wide square edge sheets.</li> </ul>	25	19.8	✓			✓	✓	✓	
<b>Flexible</b>	<ul style="list-style-type: none"> <li>A 6.5mm thick plasterboard with an enhanced core to allow bending to small radii for curved walls and ceilings.</li> <li>Designed for installation as a two layer system.</li> <li>Long edges are recessed for flush jointing.</li> </ul>	6.5	4.3						✓	
<b>Glasroc F</b>	<ul style="list-style-type: none"> <li>A 30mm thick paperless gypsum board with glass fibre reinforced core.</li> <li>Designed for single-layer installation, without jointing, to provide fire protection to structural steel columns and beams.</li> <li>1200mm wide square edge boards.</li> </ul>	30	25.5	✓		✓				

# Components

## Fasteners

Screws for fixing plasterboard and fibre cement sheets to steel framing must be appropriate for the atmospheric conditions.

- Gyprock Type S Needle Point (NP) Screws for 0.5 – 0.8mm BMT steel sections
- Gyprock Type S Drill Point (DP) Screws for 0.8 – 2.4mm BMT steel sections
- Gyprock Plasterboard Laminating Screws.

### Screws For Fixing Components To Steel Framing

- Drill-point, wafer head screw for fixing H-Stud to base Steel Angles, and for fixing J-Track, Steel Angles, Wall Clips and Aluminium Straps to steel framing

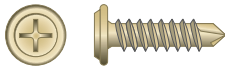

Size	Pack	Qty	Order No.
10g x 16mm	Loose	1000	169079
10g x 30mm	Loose	500	169080

- Type S plasterboard laminating screw, course thread, for fixing 16mm Gyprock Fyrchek plasterboard to the Shaft Liner MP panels.

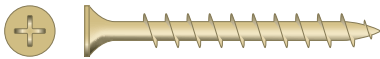

Size	Pack	Qty	Order No.
10g x 38mm	Loose	500	109259

- Type S #8-15 x 20mm NP Screw for fixing single layer 13mm plasterboard to studs.

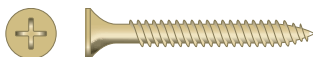

Size	Pack	Qty	Order No.
6g – 18 x 25mm	Loose	1000	10606

### Fasteners for fixing J-Tracks and Steel Angles to concrete. (Supplied by RONDO®)

- Must be an appropriate fastener suitable for safety critical, cracked concrete, seismic and fire rated applications with minimum embedment depth of 50mm, e.g., M6 x 60mm RONDO CERT-R-FIX, for fixing J-Track sections and Steel Angles to concrete. Designed and supplied by others.



Type	Size	Pack
CH06 (60mm)	M6 x 60mm	100
CH06 (80mm)	M6 x 80mm	100
CH10	M10 x 60mm	100

## Gyprock Acrylic Stud Adhesive

- Gyprock Acrylic Stud Adhesive is coloured blue for easy identification. It can be used in temperatures not less than 5°C.
- Contact surfaces must be free of oil, grease or other foreign materials before application. The adhesive is applied with a broad knife to form 25mm diameter by 15mm high walnuts. This product is suitable for use with pre-painted metal battens and some treated timbers. Always follow directions on packaging.

### WARNING

- Stud adhesive must not be relied on in fire rated systems.
- Daubs of adhesive must never coincide with fastener points.
- Stud adhesive does not constitute a fixing system on its own and it must be used in conjunction with nail or screw fasteners.



Pack	Qty	Order No.
Sausage	900g	95082
Bucket	5.5kg	10091

## Sealants

- Gyprock Fire Mastic fire rated sealant for use where detailed.



Pack	Qty	Order No.
Sausage	600ml	10924

- CSR FireSeal fire rated sealant for use where detailed.



Pack	Qty	Order No.
Sausage	600ml	121022

- Gyprock Wet Area Acrylic Sealant.



Pack	Qty	Order No.
Tube	450g	10902

### Steel H-Stud

StrataWall systems incorporate 25mm H-Studs to support the Shaft Liner MP panels at all vertical joints. It is made from 0.55mm BMT G2 Z275 galvanised steel.

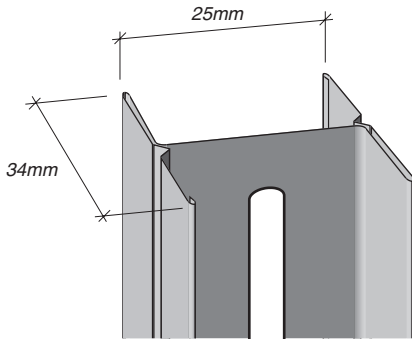

Length	Order N°
3000mm	39156
3600mm	122926

### J-Track

Steel J-Track (Rondo N°P140 Wall Track) is a wall track manufactured by Rondo from 0.55mm BMT G2 Z275 galvanised steel. The J-Track is used in the following applications:

- Support of Shaft Liner MP panels at the ends of the wall.

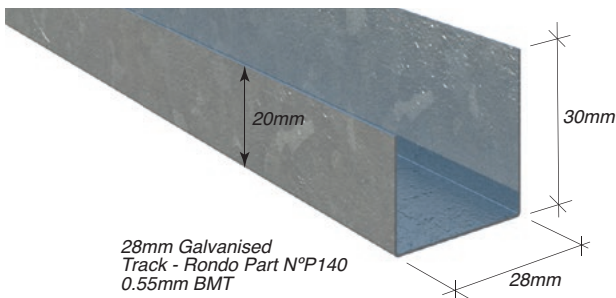

Length	Order N°
3000mm	10465

### J-Track – Extended Leg

Steel J-Track Extended Leg is a top track manufactured by Rondo from 0.55mm BMT G2 Z275 galvanised steel. The J-Track Extended Leg is used in the following application:

- Support of Shaft Liner MP panels at the top of the wall

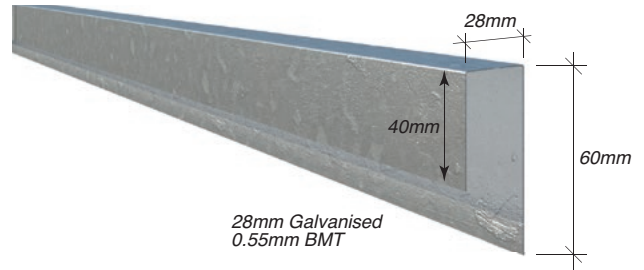

Length	Order N°
3000mm	484251

### Steel Angle

Steel Angle (Rondo No 530 Heavy Duty Angle) is manufactured by Rondo from 1.15mm BMT G2 Z275 galvanised steel. The Steel Angle is used in the following applications:

- Base support of Shaft Liner MP panels and H-Stud sections at floor level.
- Vertical edge support of Shaft Liner MP panels at wall junctions.



Length	Order N°
3000	

## Gyprock Aluminium Wall Clip

- Used to support the J-Track or Steel Angle sections at the top and base of the wall at the ends. The Wall Clip is manufactured from 1.6mm thick aluminium. Suitable up to a 40 mm Cavity.

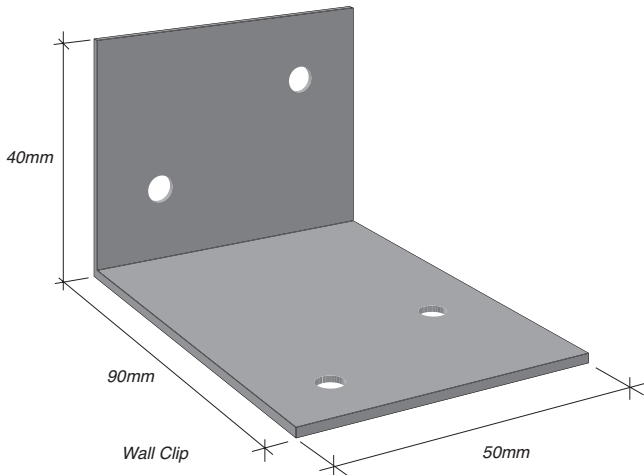

Size	Pack Qty	Order N°
40 x 90 x 50mm x 1.6 BMT	1	454513

## Gyprock Aluminium Strap

- Used to support the J-Track or Steel Angle sections at the top and base of the walls at junctions. The Wall Clip is manufactured from 1.6mm thick aluminium. Suitable up to a 40 mm Cavity.

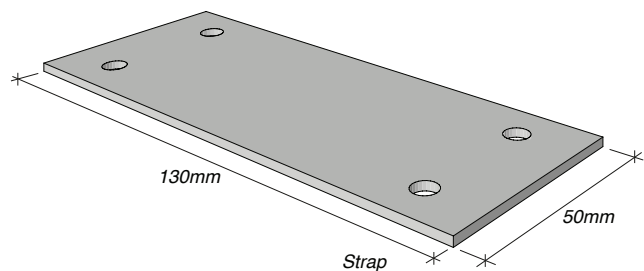

Size	Pack Qty	Order N°
130 x 50mm x 1.16 BMT	1	193172

## Cemintel CeminSeal® Wallboard

Cemintel CeminSeal® Wallboard ("Wallboard") features an embedded micro waterblock technology that repels water, preventing water penetration into the panel and hence providing a durable sheet that will not rot, swell or warp when properly installed.

Wallboard is a superior lining for wet areas such as bathrooms and laundries, and for the construction of impact resistant walls. Wallboard has a recess on both long edges so that sheets may be taped and set. Once jointed it may be tiled, painted or wall papered as desired.

## Insulation Materials

CSR Fire and Acoustic Systems incorporate Bradford Glasswool and Rockwool insulation. These products have undergone significant acoustic testing and have a proven track record of performance and durability in service. Additional information on Bradford Insulation materials is available by telephoning CSR Bradford on 1300 850 305.

Although insulation materials are often specified for thermal resistance, they can contribute significantly to the acoustic performance of wall and ceiling systems. CSR only recommends materials that have been tested for fire and acoustic applications, have proven durability, and are supported by their manufacturer for these applications. Should other insulation materials be used, the manufacturer of those materials must verify the performance of the complete system, CSR will not support the performance of substitute materials.



Insulation Product
50mm Bradford Glasswool Partition rolls, 450 or 600mm – 14kg/m <sup>3</sup> – R1.2
75mm Bradford Glasswool Partition rolls, 450 or 600mm – 11kg/m <sup>3</sup> – R1.7
75mm Bradford Glasswool Partition rolls, 450 or 600mm – 14kg/m <sup>3</sup> – R1.8
110mm Bradford Glasswool Partition rolls, 600mm – 11kg/m <sup>3</sup> – R2.4
100mm Bradford Glasswool Partition rolls, 450 or 600mm – 14kg/m <sup>3</sup> – R2.5
88mm Bradford SoundScreen R2.5 Wall rolls – 24kg/m <sup>3</sup> – R2.5
Bradford Rockwool*

\*Cavity seals noted as Rockwool must be of minimum density 50kg/m<sup>3</sup> such as Bradford Party Wall Sealer.



# Design Considerations

## Building Design

Gyprock StrataWall Systems are non-loadbearing walls, designed to NCC 2022, including a permissible pressure of 0.25kPa at a maximum height of 3.18m. All walls must be designed for the applied loads, including seismic loads and wind loads where applicable.

Shelf loads and internal wind pressures must be determined by the project structural engineer and the stud framing must be designed as pressure sealed systems. The pressure sealed outer plasterboard linings resist the imposed internal wind pressures and prevent these loads being imposed on the central wall of Shaft Liner MP panels and H-stud sections. The central wall is not suitable for shelf loading.

Under imposed seismic actions the central wall only supports imposed loads due to self-weight. For Australian conditions, the seismic loads have been independently assessed in accordance with AS1170.4 Section 8.2 as structurally adequate for a maximum height of 3.3m. For a maximum design ultimate pressure of 0.348kPa, the StrataWall central wall has been independently assessed as structurally adequate for a maximum height of 3.3m. The central wall is located within the wall and should experience minimal wind pressure loads, as the linings on the internal stud framing and the junction of the internal StrataWall and external façade wall shall be sealed to prevent air access into the StrataWall. The project structural designer can determine design pressure differential acting on the central wall within the StrataWall and advise on the adequacy. The top J-Track Extended Leg and base Steel Angle are to be fixed to the concrete structure at 600mm maximum centres and 150mm maximum from the ends with each fixing designed to resist the loads to satisfy safety critical, cracked concrete, seismic and fire rated requirements of the project.

The design of the plasterboard lining and non-loadbearing stud framing of the outer walls shall be in accordance with CSR Gyprock and the framing manufacturer's instruction, respectively. The non-loading stud framing of the outer walls shall be in accordance with AS/NZS 4600 or AS3623 for steel framing.

Aluminium Wall Clips or Aluminium Straps are required for lateral restraint of the end of the central wall at a movement joints, where the vertical J-Track/Steel Angle at a junction is not fixed to the steel framing of the intersecting wall. Aluminium clips in locations other than wall junctions do not meet the requirement for discontinuous construction, which may be unacceptable in some rooms.

StrataWall may be exposed to wind during construction for up to three months, and the central wall of Shaft Liner MP panels and H-Stud sections must be adequately propped until the building is enclosed.

## Installation of System Wall Clips and Straps

In all areas, suitable allowance for construction tolerance should be made to ensure the minimum gap is maintained. Clips or straps must be screw fixed to the J-Track or Steel Angle sections and stud framing. Fixing directly to the Shaft Liner MP panels is not permissible.

## System Selection

Refer to Gyprock The Red Book 01 for an extensive range of systems with associated fire and acoustic performance values. Options are available for wet areas, for rooms requiring damage resistance, and for premium acoustic ratings.

## Fire Resistance

StrataWall details in this guide have been assessed by NATA registered labs in accordance with the general principles of AS1530.4. They are suitable for the stated non-loadbearing FRL rating when designed in accordance with the noted design considerations, and when installed in accordance with the details in this guide.

The systems are designed to allow the side exposed to the fire to collapse into the fire side, leaving the central wall fire barrier of Shaft Liner MP panels, H-Stud sections, and non-fire side stud framing wall in place.

Details for the perimeter of StrataWall systems adjoining external wall claddings are provided using Rockwool or fire grade sealants. Where Rockwool is used it must be compressed lightly to fill the gap between the cladding and the end of the central wall. Rockwool batts may be trimmed to suit the gap dimensions. Fire grade sealant is used between the J-Track and cladding, over any wall wrap.

## Acoustic Performance

The acoustic performance of wall systems is expressed in terms of  $R_w$  and  $R_w + C_{tr}$ . The systems have been assessed by PKA Acoustic Consulting, and the sound insulation ratings refer to expected laboratory performance. The site performance of the systems may be affected by sound flanking, the effectiveness of workmanship, and the inclusion of structural elements and bridging items. The building designer must pay special attention to airborne and structural flanking paths to minimise the difference between laboratory and field performance.

Aluminium Wall Clips and Aluminium Straps are only to be installed at the junctions as shown in the details. Using additional clips and straps within the storey height will reduce the acoustic performance of the wall and may not meet the requirement for discontinuous construction.

For flanking sound control when wall insulation does not extend full wall height, it is required that the suspended ceiling of each story consists of plasterboard 10mm or thicker, and that the ceiling spaces are at least 250mm in depth. Insulation is required in the ceiling space, extending 1200mm minimum on each side of the wall over the ceiling. The insulation is to be Glasswool or Rockwool of 75mm or thicker, such as Bradford R1.5 Gold batts or partition rolls (refer Figure 12). For ceiling spaces less than 250mm in depth, wall insulation is to extend the full wall height, (refer Figure 11). Similarly for flanking at the junction of the StrataWall systems with external walls, the interior lining of the exterior wall must be a minimum of 10mm Gyprock plasterboard. The cavity of the external wall on each side of the StrataWall system must be filled with insulation of at least 75mm Bradford R1.5 Gold batts or partition rolls and extend a minimum distance of 600mm from the Gyprock StrataWall system.

Ceiling penetrations must be acoustically treated in areas closer than 1.2m of the Gyprock StrataWall system, except for LED downlights. These must be no closer than 900mm apart, with penetrations neat and tight to the fitting.

All systems achieve  $R_w \geq 45\text{dB}$  and  $R_w + C_{tr} \geq 40\text{dB}$  for services in the adjoining unit.

## Substitution

Plasterboard and insulation materials must be as specified in the Construction Details section in this guide and System Selection within Gyprock The Red Book 01.

No statement of performance and product warranty will be provided by CSR when other brand products are used.

## Exposure to Weather

Once erected, it is recommended that the central wall barrier of Shaft Liner MP panels and H-Stud sections are protected from rain and freestanding water. The use of a covering can prevent the formation of mould, and can avoid delays in allowing boards to dry before internal linings are applied.

**IMPORTANT – Panels with physical damage to either the core or paper face must be replaced.**

## Installation of Plasterboard Linings

Walls may be built to achieve a specified 'Level of Finish' as defined in AS/NZS 2589. The Level of Finish specified can have requirements for frame alignment, jointing and back blocking methods, and sheet orientation.

Gyprock plasterboard sheets may be installed vertically or horizontally, although for some Levels of Finish horizontal sheeting must be used. Walls lined with Gyprock moisture resistant plasterboard may be finished with tiles.

Refer to the appropriate installation manual:

- Gyprock The Red Book 02 – Residential Installation Guide.
- Gyprock The Red Book 03 – Commercial & Multi-Residential Installation Guide.

## Fyrcek Laminated Layer

For StrataWall with 16mm Gyprock Fyrcek laminated to the central wall (of Shaft Liner MP and H-Studs), the laminated layer is required only on one side of the central wall and must be fixed with laminating screws at maximum spacings detailed in the installation diagram.

The vertical joints of the laminated Fyrcek sheets shall be positioned to not coincide with the H-Stud locations. The sheet joints must be neatly formed, and gaps up to 3mm wide are acceptable and need to be filled or set.

## Services

StrataWall systems allow penetrations to be made in the wall linings. StrataWall systems tested have been fire tested with services including PVC (65mm max. diameter), copper plumbing, GPO's and electrical services installed in both wall leaves with acceptable performance. Services may be installed through the stud framing or, with a minimum 10mm clearance to the central Shaft Liner MP barrier and may be fixed to the back of studs. Simply prepare neat cut holes with a 6mm maximum clearance. Back-to-back services are permitted. Penetrations for plumbing and electrical services may be installed without the need for acoustic caulking, baffles, or fire seals.

No penetrations are permitted through the central wall fire barrier of Shaft Liner MP panels and H-Stud sections.

Bathtubs may be built into a StrataWall system as detailed without reducing the acoustic performance. The bath material must consist of steel at least 1.0mm thick, or acrylic of at least 5.0mm thick.

**IMPORTANT: The perimeter of the bathtub must be fully sealed with a fire and/or an acoustic rated wet area sealant to provide a fire, acoustic and air barrier as required between the internal room and the central wall of the Gyprock StrataWall System. A laminated Fyrcek plasterboard layer shall be installed on the central wall as per system approved construction details.**

## Control Joints

Control joints must be installed to allow for structural movement. Allowance for movement must be made through the frame, lining and any tiles.

Control joints must be installed at the following locations:

- At all construction joints in the building.
- At changes of the structural support system.
- At junctions with other building elements.
- At changes of the lining material.
- For non-tiled internal walls with plasterboard outer layer – at 12m maximum centres.
- For tiled internal walls with plasterboard with outer layer – at 6m maximum centres.

## Fixing & Jointing

Refer to:

- Gyprock The Red Book 02 – Residential Installation Guide.
- Gyprock The Red Book 03 – Commercial & Multi-Residential Installation Guide.
- Ceminseal® Wallboard Installation Guide – Interior Steel Framed Walling.

**Table 2: Maximum Wall Height With Rondo Lipped Steel Studs – Non-Loadbearing Internal Walls**  
 – Walls (0.375kPa ULS) – Maximum FRL –/120/120 Unless Noted. Refer to Gyprock The Red Book 03 for more information

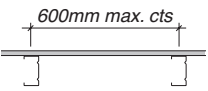
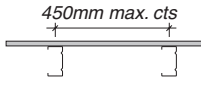
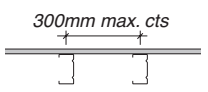
Wall Frame and Lining Configuration	Stud Size (mm)	51		64			76			92		
	BMT (mm)	0.5	0.75	0.5	0.75	1.15	0.55	0.75	1.15	0.55	0.75	1.15
	Plasterboard Linings (mm)	Maximum Wall Height (mm)										
<b>Single Studs @ 600mm max. centres</b>												
	10	2320	2600	2720	3130	3530	3200	3580	4050	3610	4130	4690
	13	2320	2600	2720	3250	3580	3240	3820	4050	3610	4180	4690
	16	2320	2600	2750	3280	3590	3250	3870	4050	3610	4200	4690
<b>Single Studs @ 450mm max. centres</b>												
	10	2520	2860	2930	3410	3870	3500	3910	4450	4050	4520	5150
	13	2520	2860	2930	3530	3930	3580	4170	4450	4050	4610	5150
	16	2520	2860	3020	3560	3950	3600	4220	4450	4050	4630	5150
<b>Single Studs @ 300mm max. centres</b>												
	10	2890	3270	3380	3900	4430	4010	4480	5090	4630	5180	5900
	13	2890	3270	3380	4010	4490	4130	4730	5090	4640	5290	5920
	16	2890	3270	3460	4050	4510	4150	4790	5090	4640	5310	5930
NOTES: <ul style="list-style-type: none"> <li>Deflection Limit is SPAN/240 to a maximum of 30mm.</li> <li>Tabulated heights do not include axial loads (except self weight) or shelf loading.</li> <li>Loadings: P<sub>ultimate</sub> = 0.375 kPa, P<sub>service</sub> = 0.25 kPa.</li> <li>Walls are not for external applications.</li> <li>All loadings in accordance with AS/NZS 1170 series.</li> <li>Linings to be full height of wall.</li> </ul>						<ul style="list-style-type: none"> <li>Walls analysed in accordance with AS/NZS 4600.</li> <li>Noggings in accordance with Table 3.</li> <li>Heights are suitable for up to two layers of the nominated thickness.</li> <li>* 1.15mm BMT Studs cannot be boxed.</li> <li>Tables have been prepared by Rondo Technical Services Pty Ltd.</li> <li>CSR recommends contacting RONDO Technical Services Pty Ltd to confirm adequacy of values for the specific project requirements.</li> </ul>						

**Table 3: Minimum Number Of Noggings For Rondo Lipped Stud Framing**

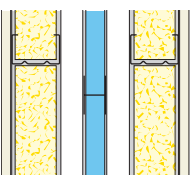
Stud Configuration	Lining Configuration	Wall Height (mm)	Number of Noggings equally spaced
	Lining One Side of each stud row	0 – 3000	1*
		3001 – 3300	2*
NOTES: <ul style="list-style-type: none"> <li>*Studs lined one side only must have an additional nogging (in each stud row) at no more than 100mm from the top of the wall.</li> <li>Where noggin is required, it should be screw fixed or crimped to both flanges of each stud.</li> <li>CSR recommends contacting RONDO Technical Services Pty Ltd to confirm adequacy of values for the specific project requirements.</li> </ul>			

# StrataWall Overview

**Head at Slab details.**  
Refer to Figure 7 and Figure 8

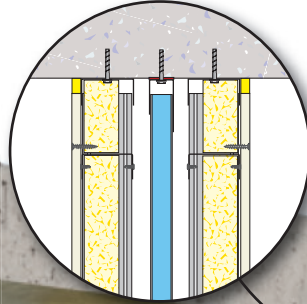

**External Junctions.**  
Refer to Figure 36  
to Figure 39

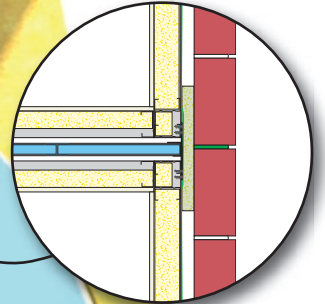

**Head & Ceiling  
Junctions.**  
Refer to Figure 11  
and Figure 12

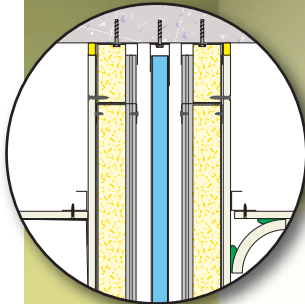

**Base at Slab details.**  
Refer to Figure 9 and Figure 10

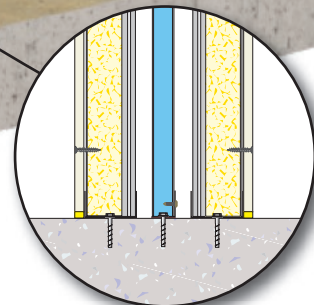

**Floor Step Down details.**  
Refer to Figure 35

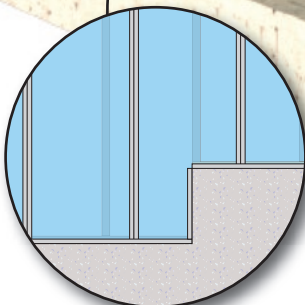

# Typical Installation Sequence

A typical construction sequence consists of installation of framing for the StrataWall central wall and installation of the stud framing to both sides.

Figure 3: Soffit, Wall And Floor Track Installed

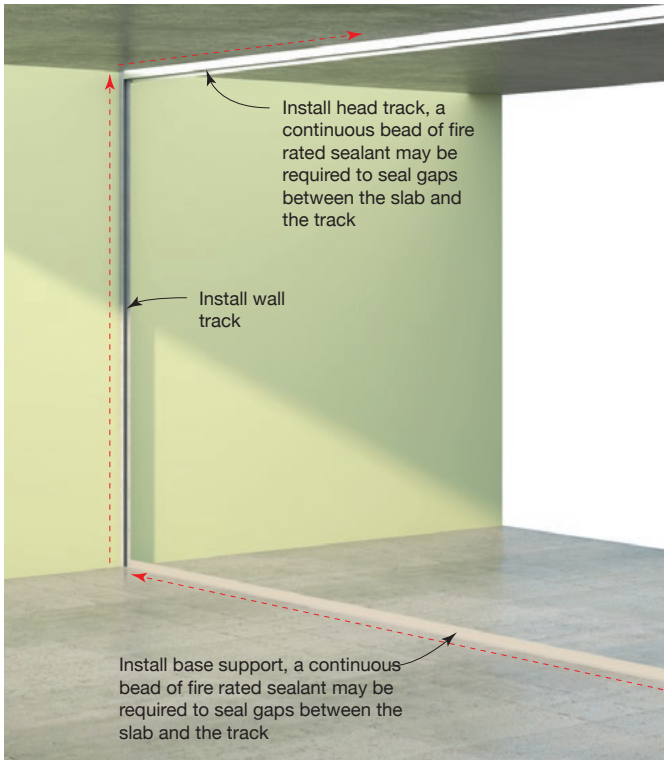

Figure 4: Shaft Liner MP Panels and H-Studs Installed

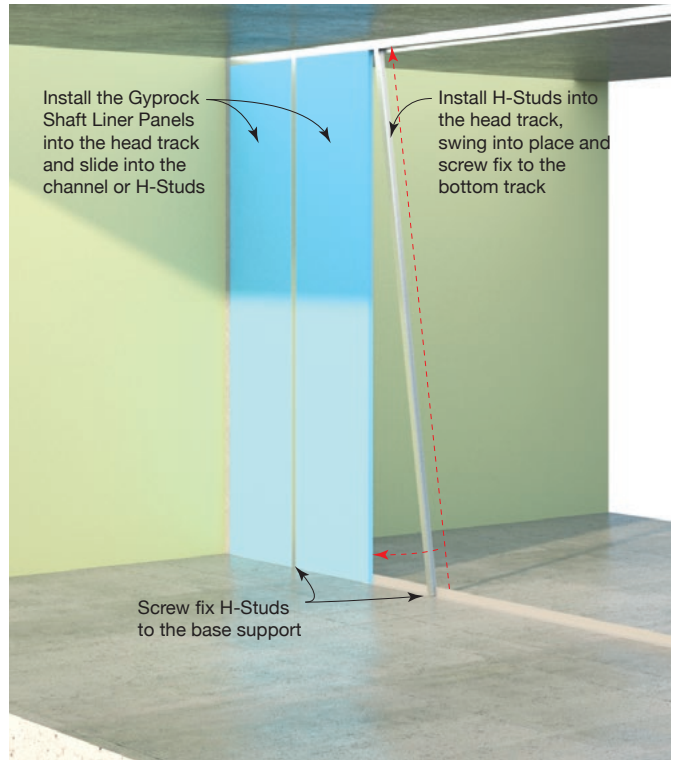

Figure 5: Stud Frame and Insulation Installed

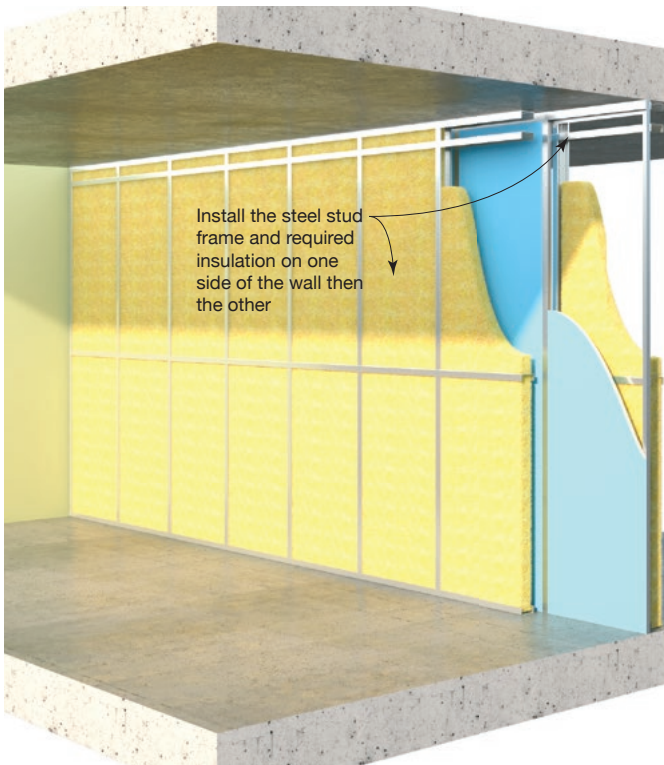
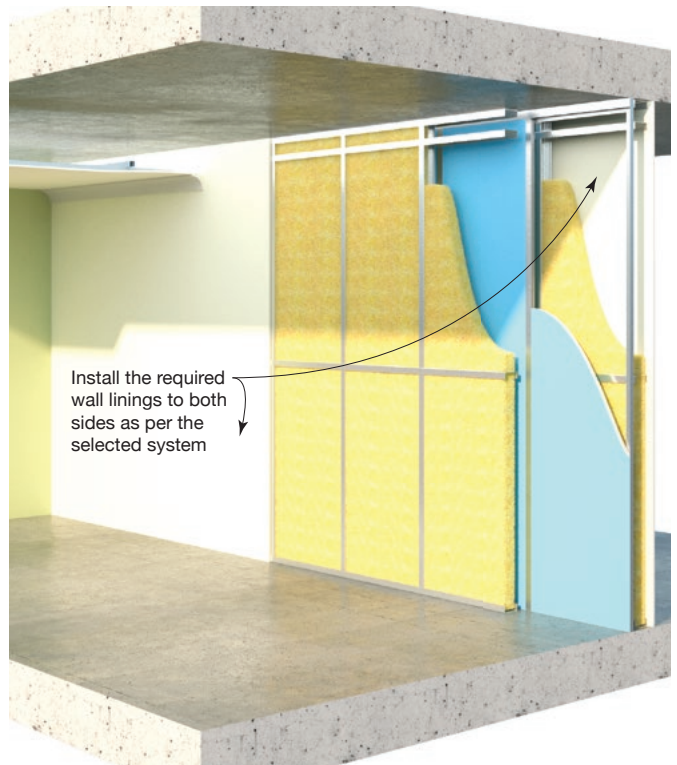

Figure 6: Wall Linings as per System Installed



# Typical Construction Details

Figure 7: Typical Head at Slab – Non-Fire Rated Wall Linings

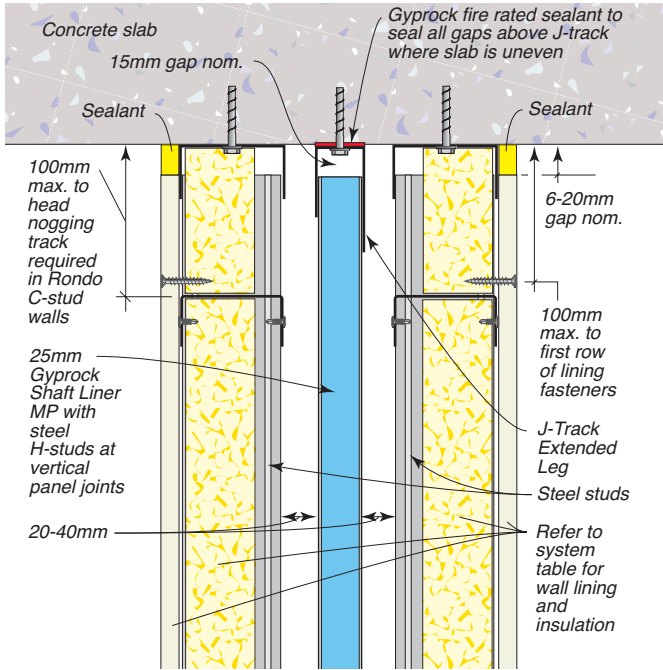

Figure 8: Typical Head at Slab – Fire Rated Wall Linings

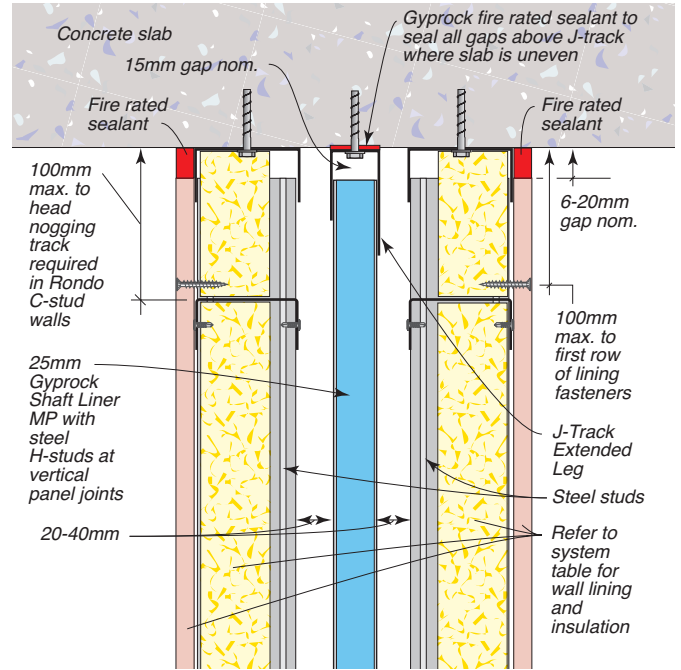

Figure 9: Typical Base at Slab – Non-Fire Rated Wall Linings

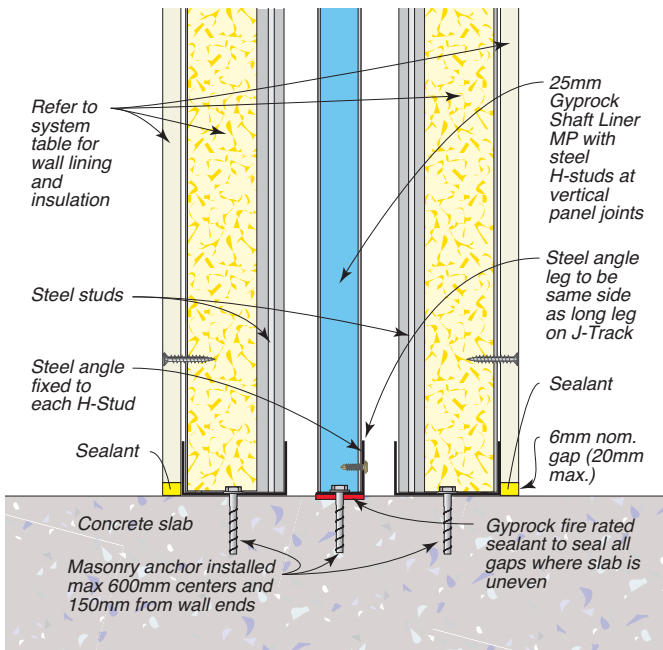

Figure 10: Typical Base at Slab – Fire Rated Wall Linings

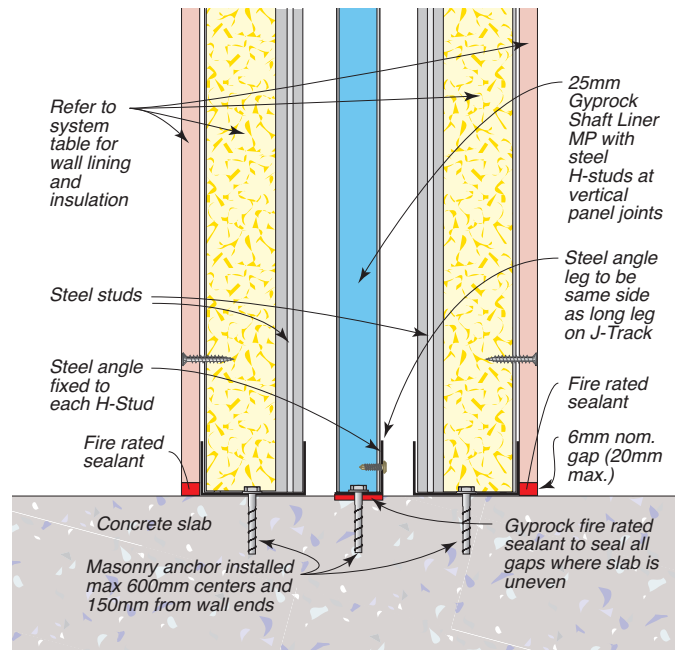

Figure 11: Through Ceiling Head with Insulation in Wall

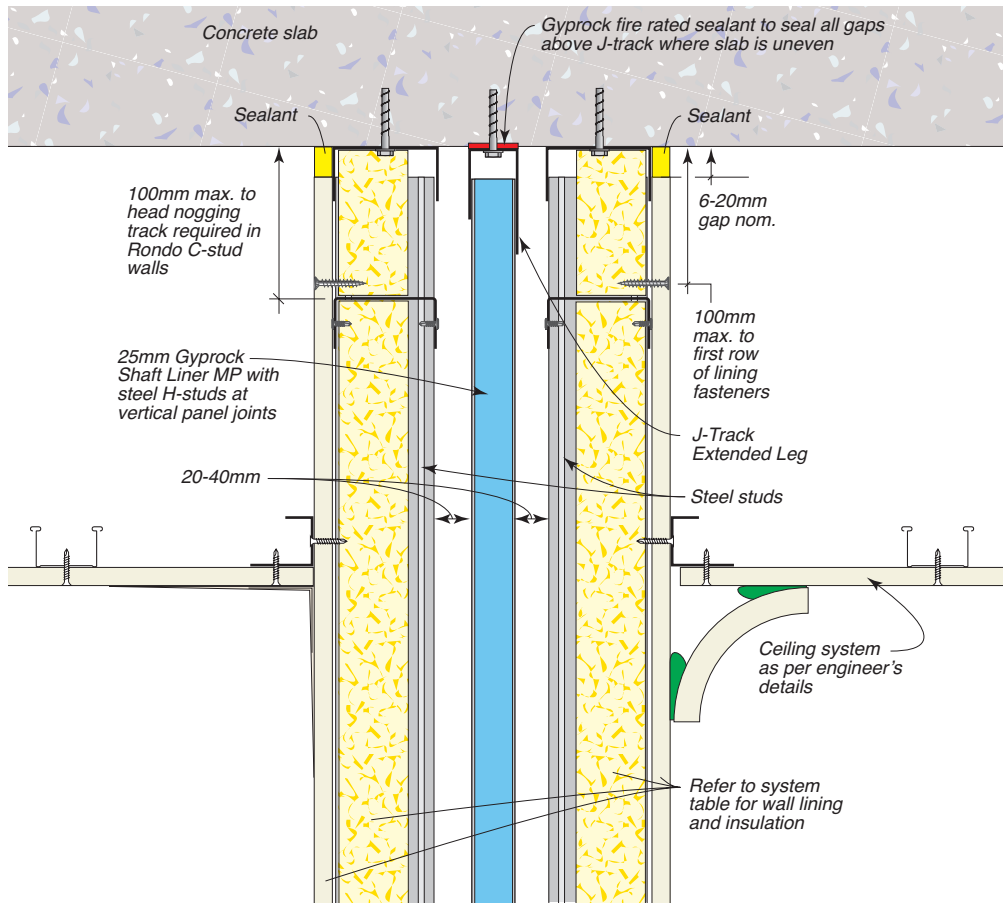

Figure 12: Through Ceiling Head with Insulation in Ceiling

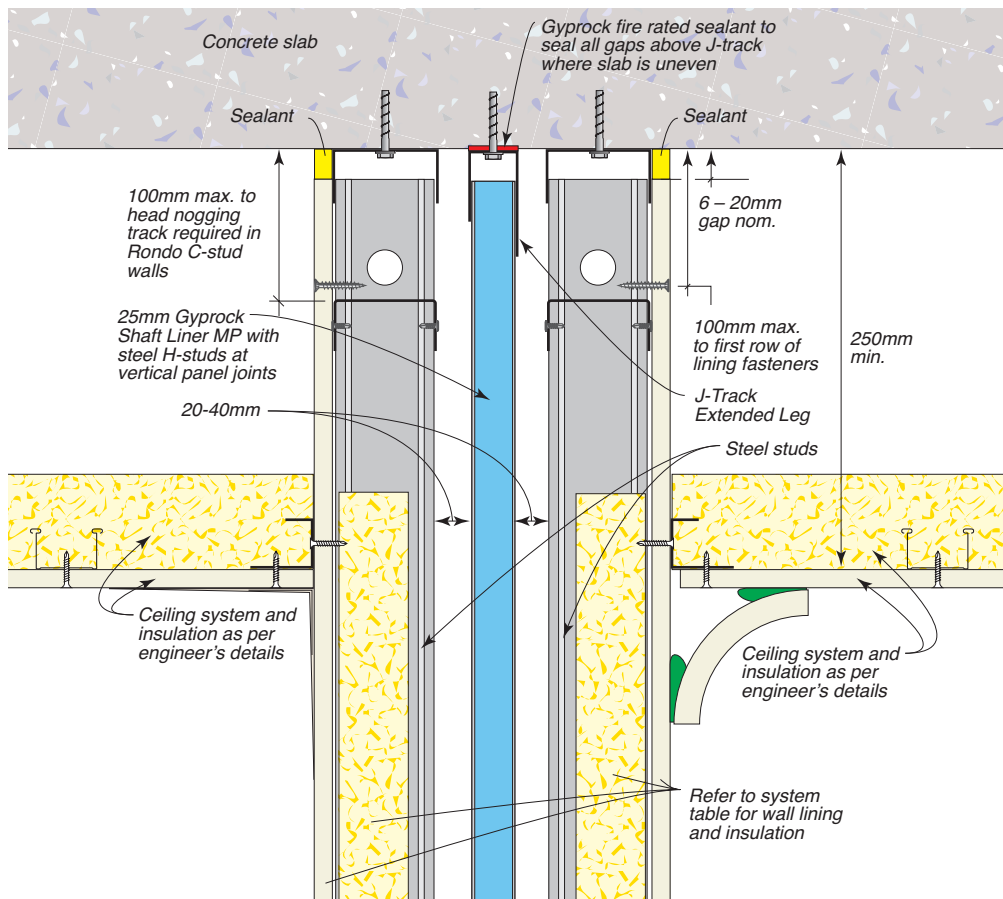



Figure 13: Fixing Aluminium Straps at Ends of Wall

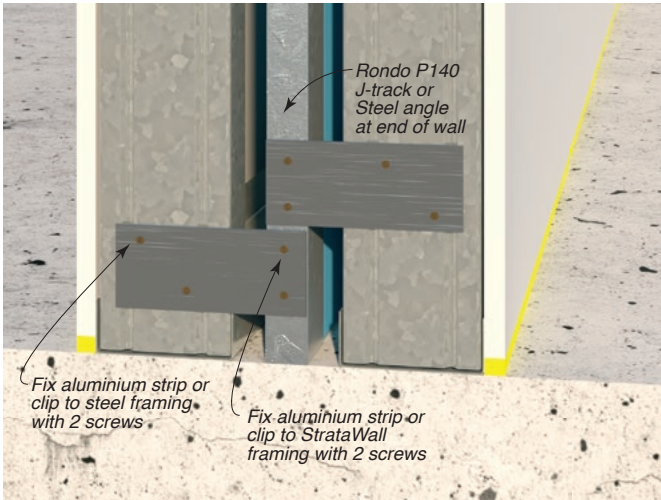

Figure 14: StrataWall to Corridor Wall Junction – With J-Track

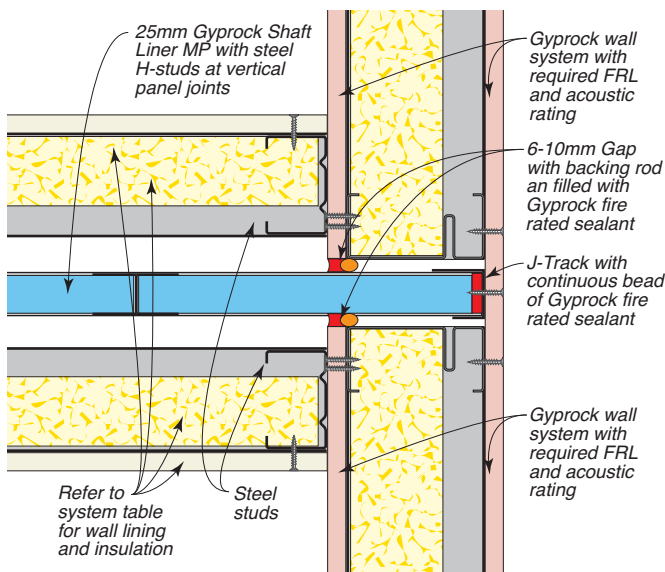

Figure 15: StrataWall to Corridor Wall Junction – With Steel Angle

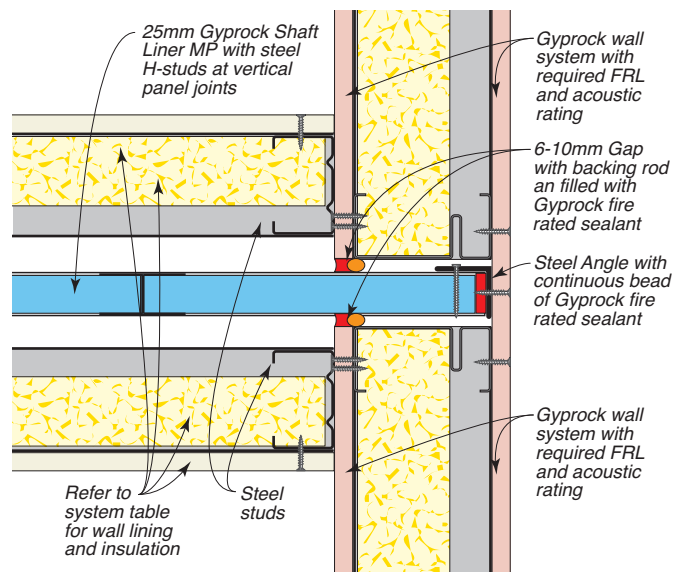

Figure 16: StrataWall to Concrete Column and Shaft Wall Junction

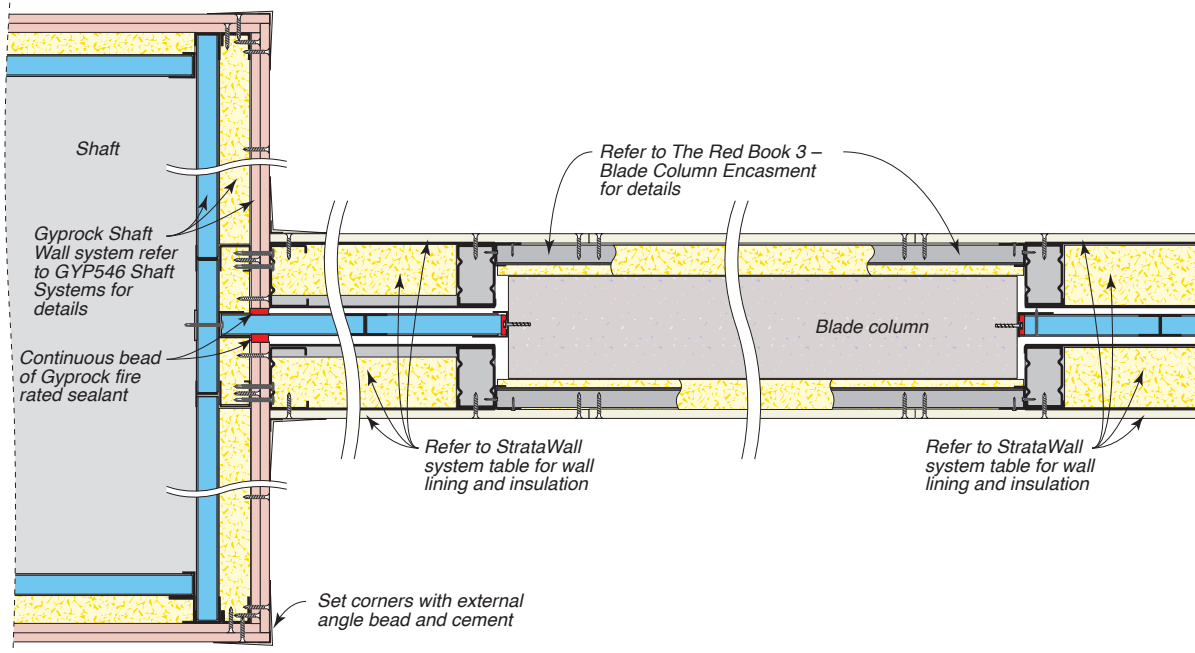

Figure 17: StrataWall to Concrete Junction – With J-Track

Figure 18: StrataWall to Concrete Junction – With Angle

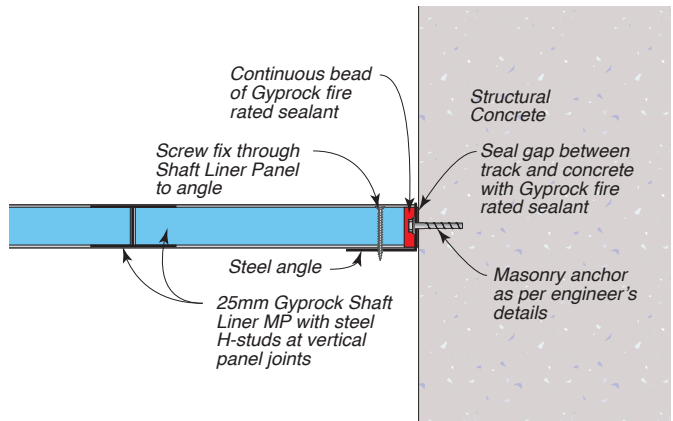
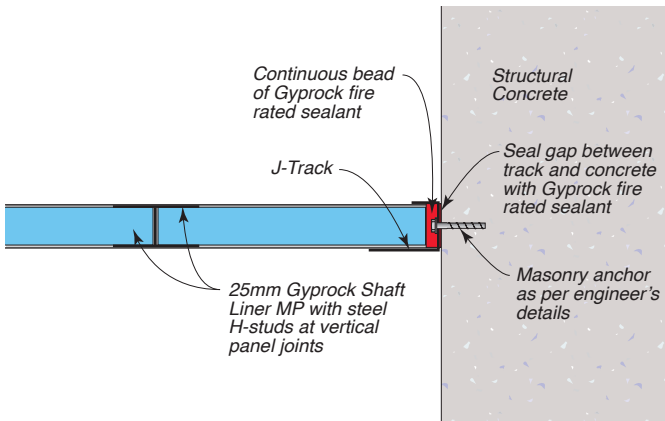

Figure 19: StrataWall to Gyprock Shaft Wall Junction

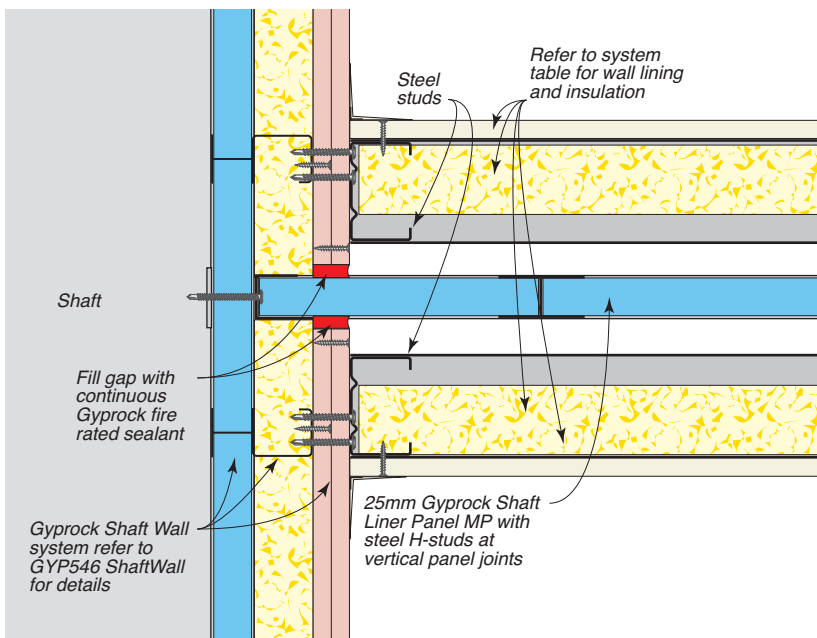

Figure 20: Non-Fire Rated Internal Wall Junction – Discontinuous Wall Lining

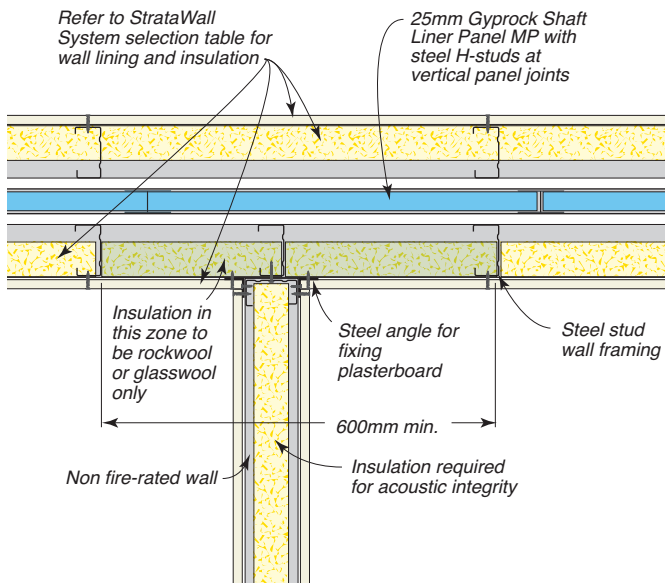

Figure 23: Non-Fire Rated Internal Wall Junction – Continuous Wall Lining

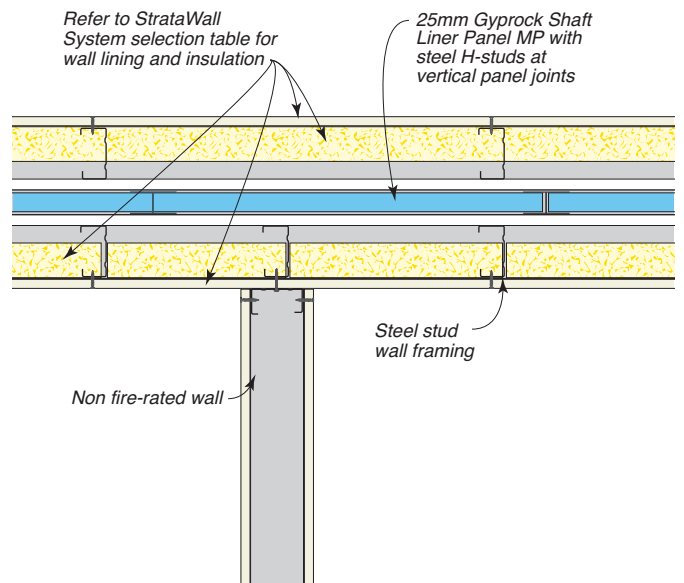

Figure 21: Junction of StrataWall to StrataWall at T-Intersection

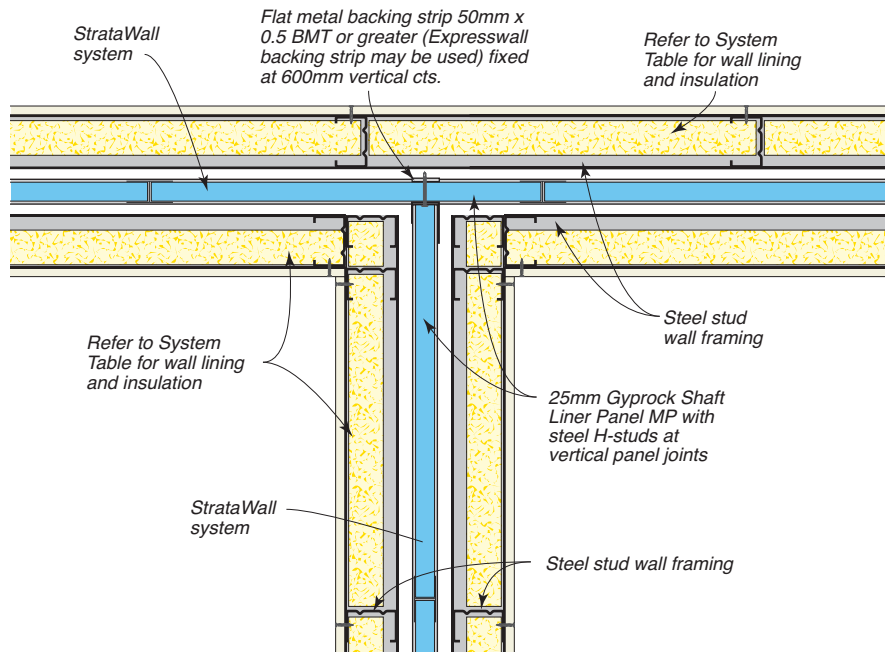

Figure 22: Fixing Method 1

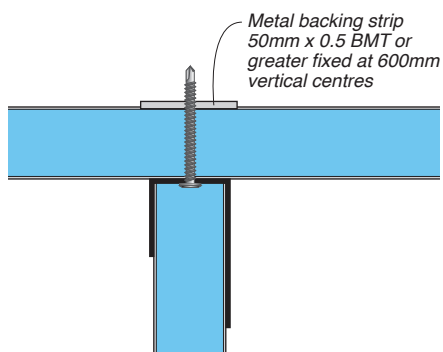

Figure 24: Fixing Method 3

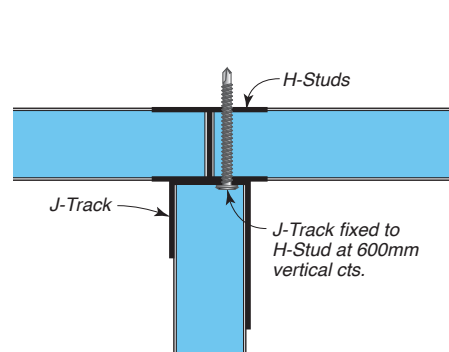
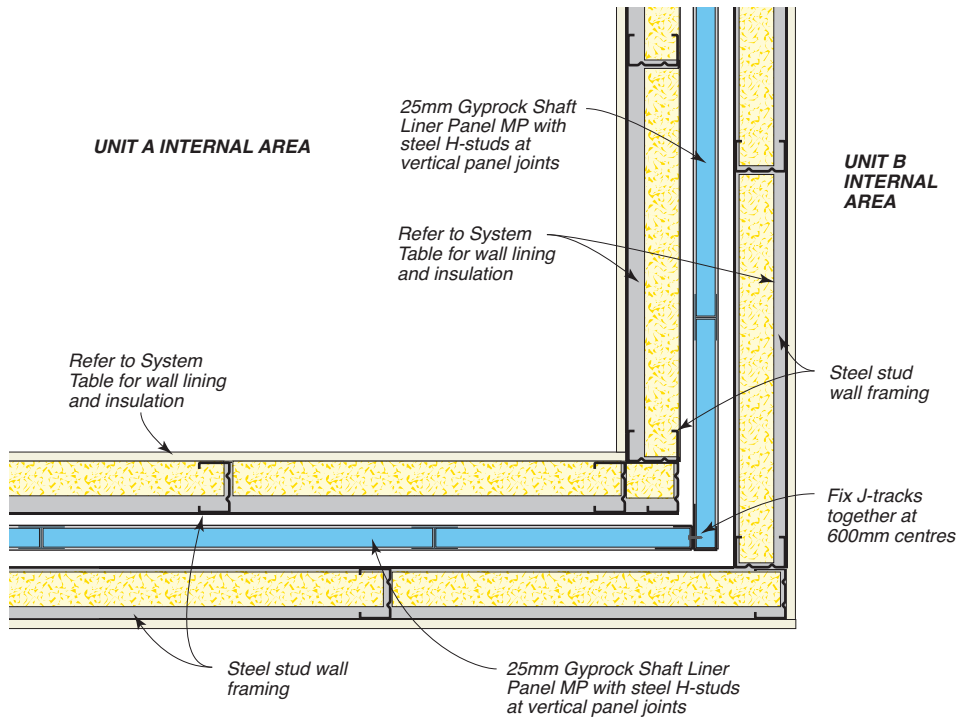

Figure 25: Junction of StrataWall and StrataWall at External Corner



# Penetration Details

Figure 26: Stratawall Typical Plumbing Penetration

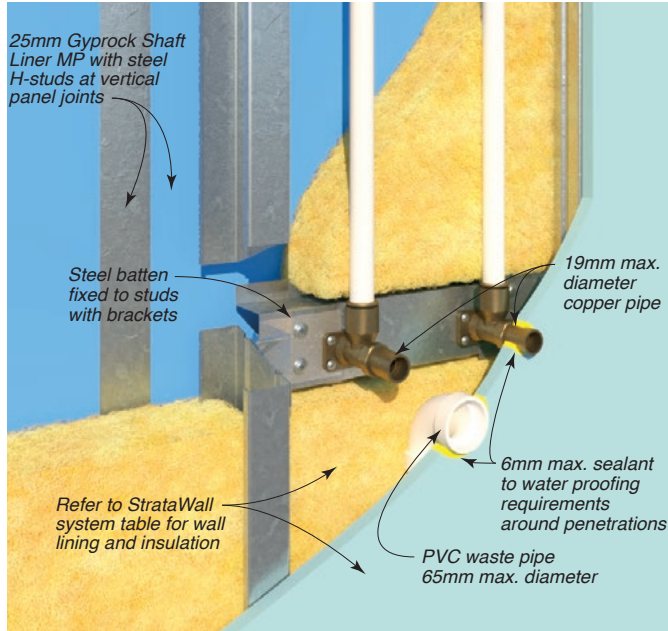

Figure 28: StrataWall Typical Plumbing Installation

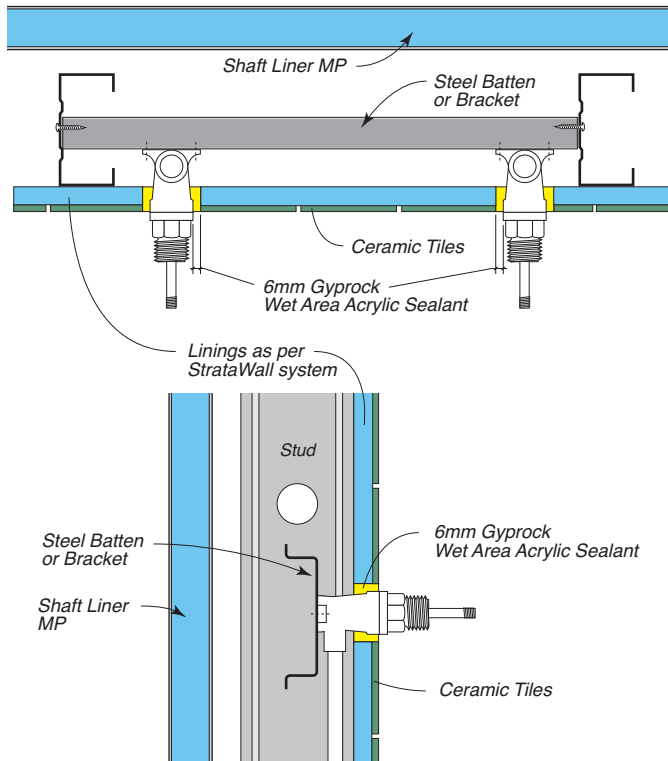

Figure 27: StrataWall Typical PVC Pipe Installation

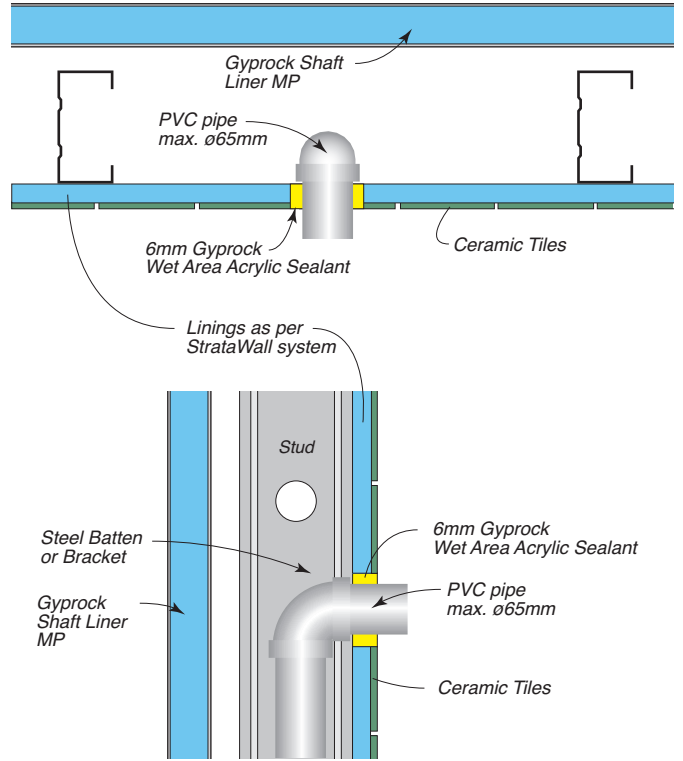
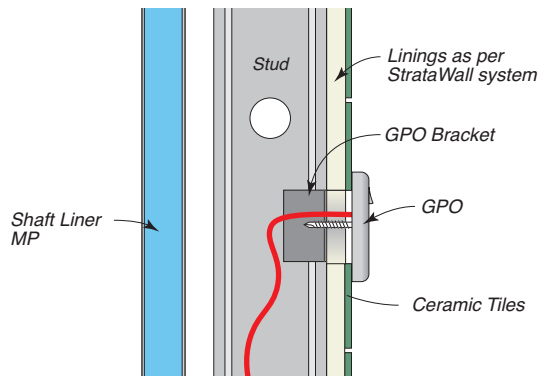
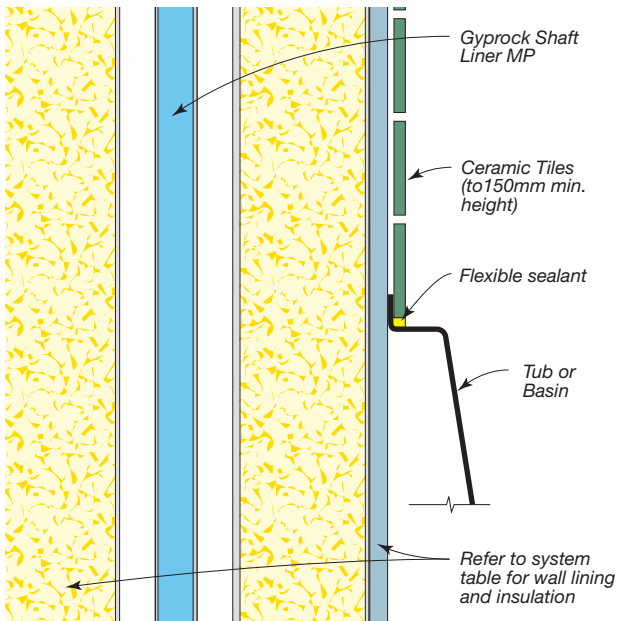

Figure 29: StrataWall Typical GPO Installation



**Figure 30: Laundry Tub/Basin Installation (continuous linings)**



**Figure 31: Alternative Tub/Basin install (Discontinuous Linings)**

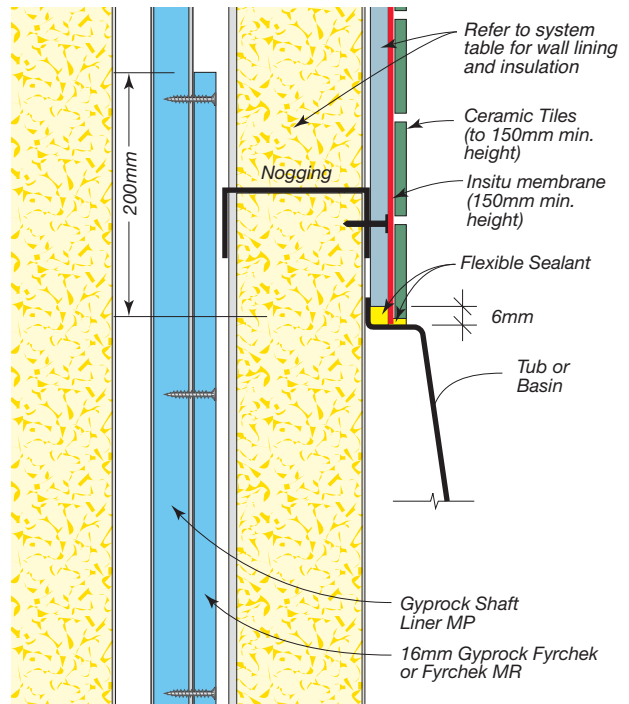

**Figure 32: Bath Installation**

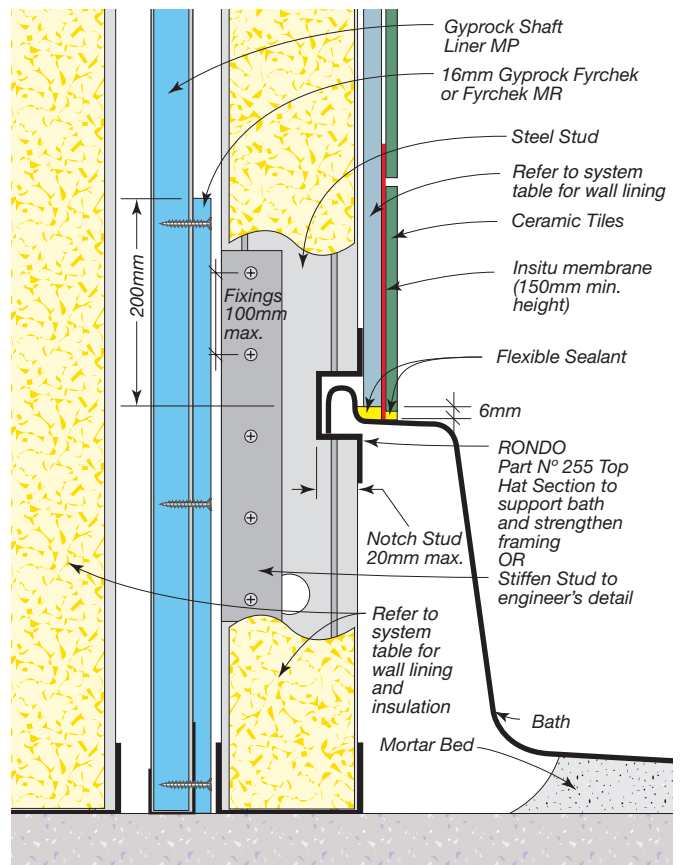

Figure 33: Typical Penetration Features

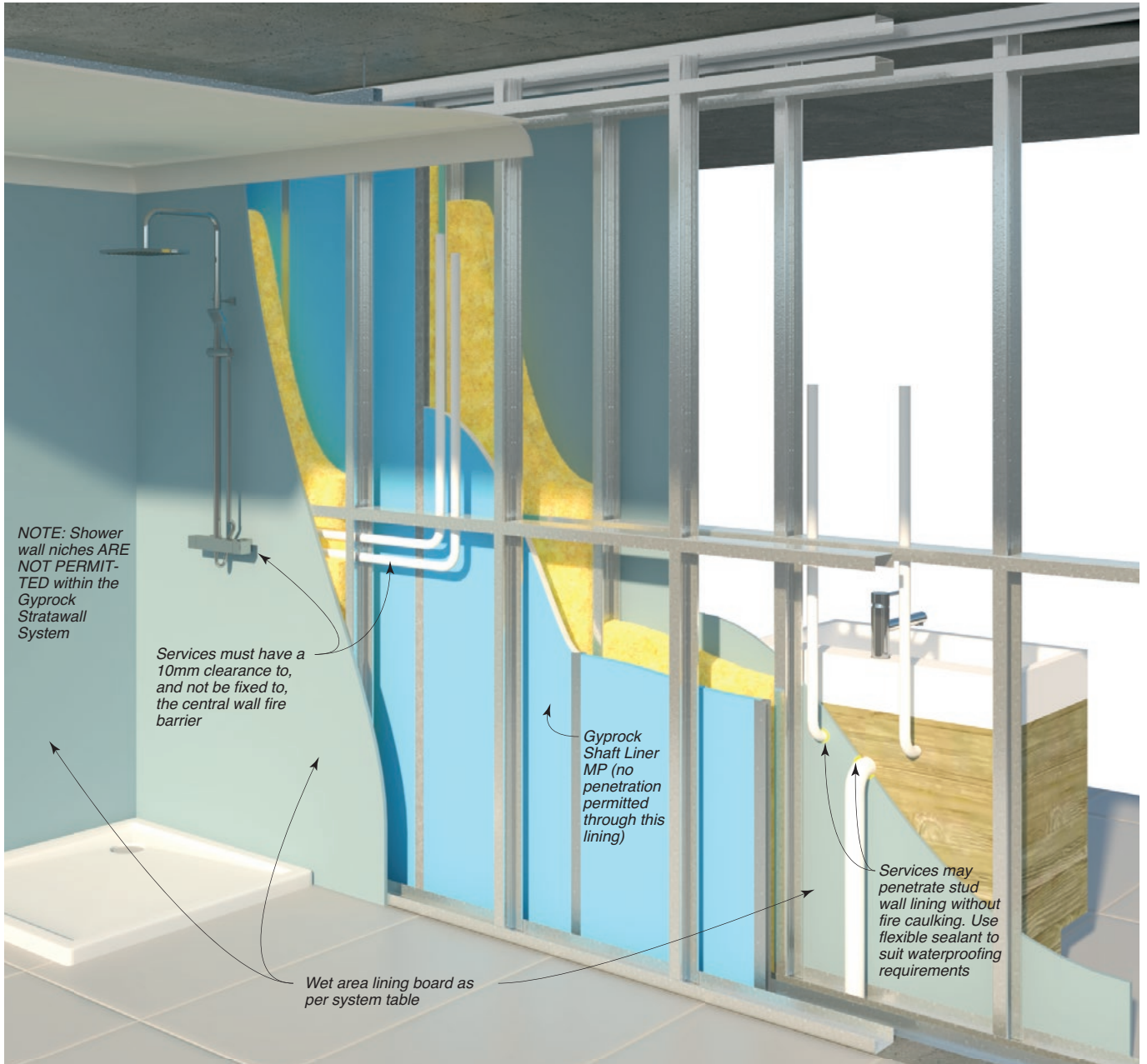

Figure 34: Installation of Fyrchek Plasterboard Lamination

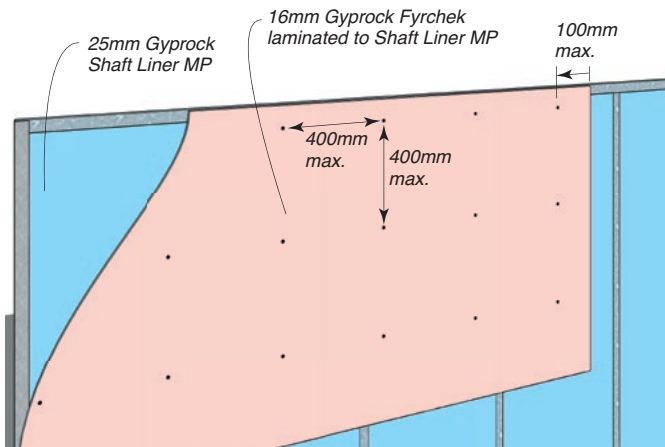
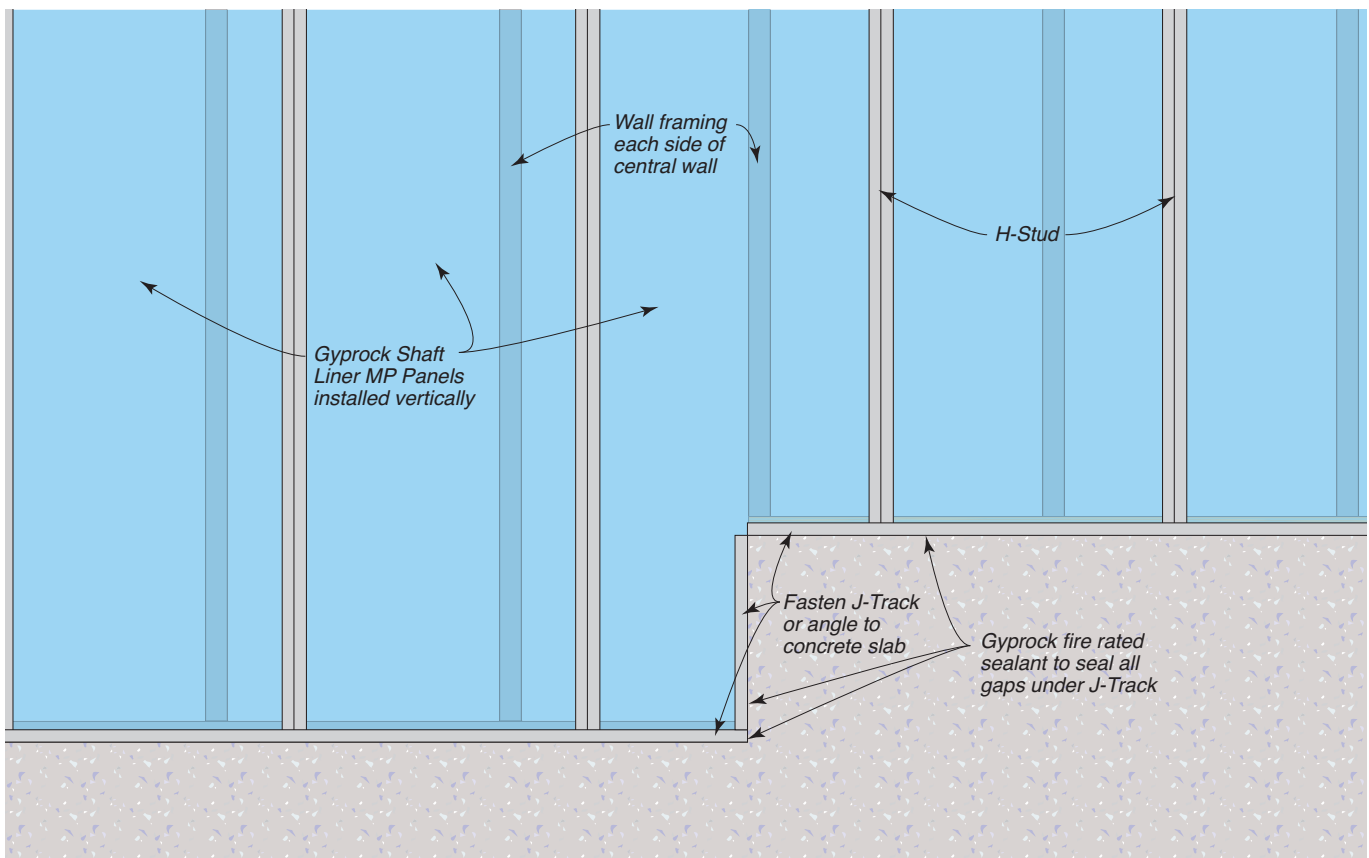

Figure 35: Floor Step Down with Vertical Shaft Liner MP Panels





# External Junction Details

Figure 36: Junction of StrataWall and External Wall with Hebel AAC or Steel Sheet Cladding

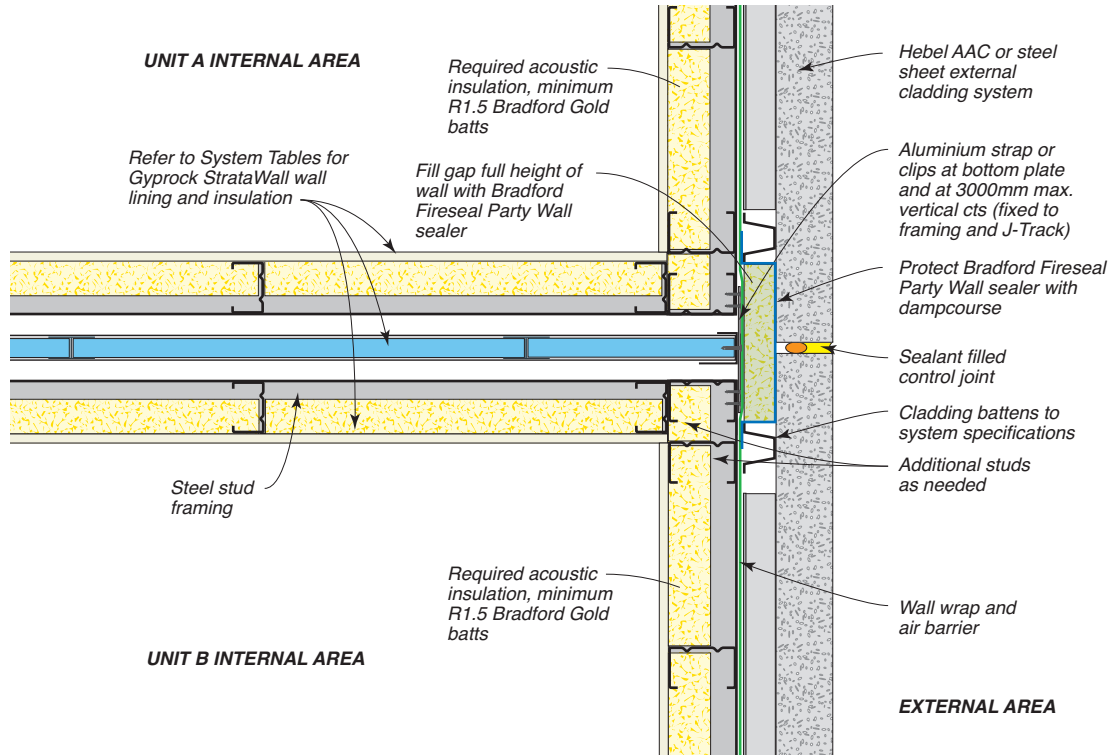

Figure 37: Junction of StrataWall and External Wall with Fibre Cement Cladding on Battens

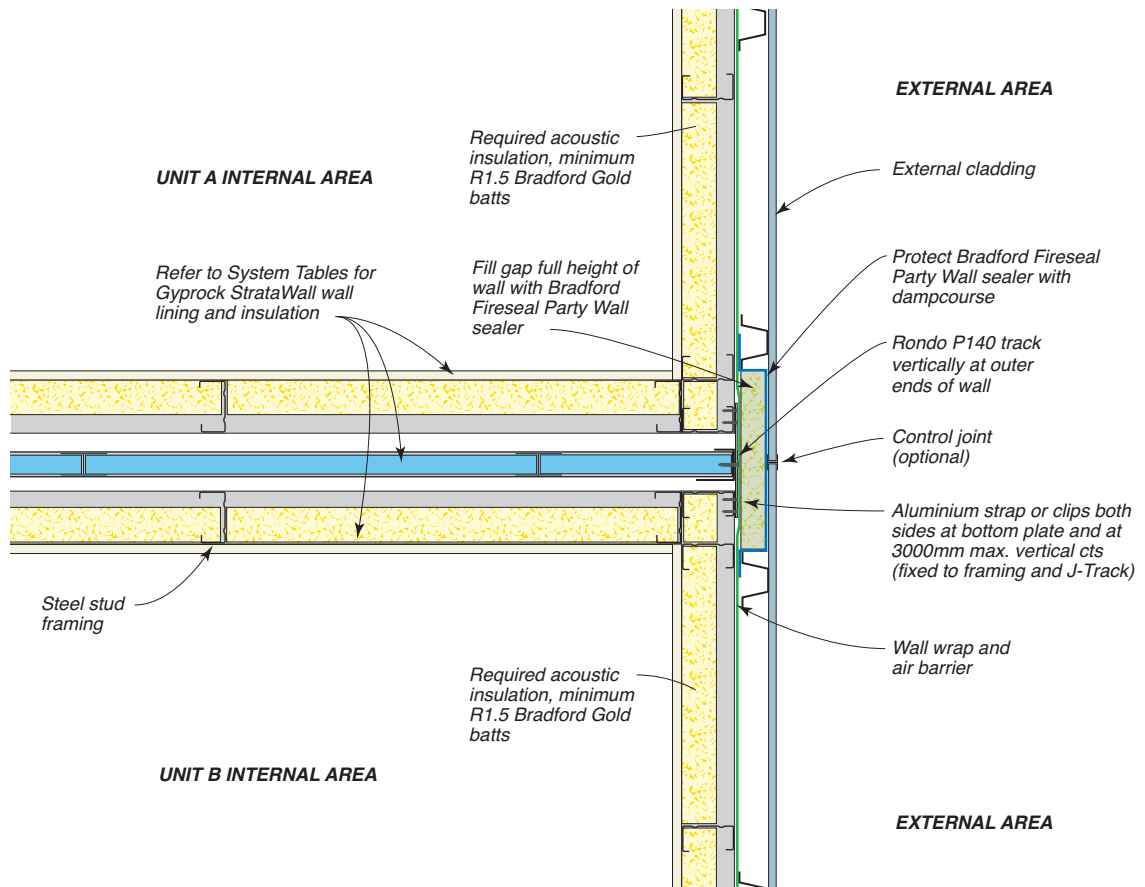

Figure 38: Junction of StrataWall and External Brick Veneer Wall

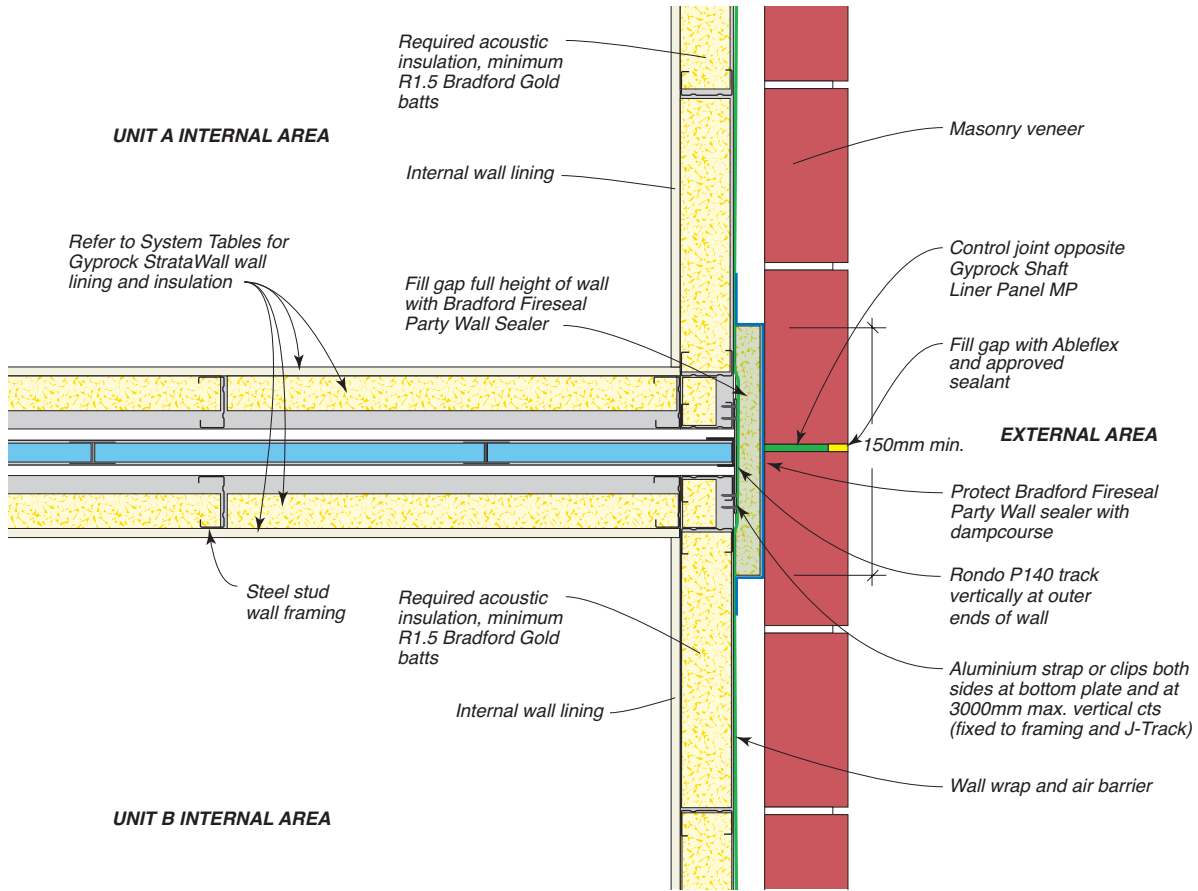
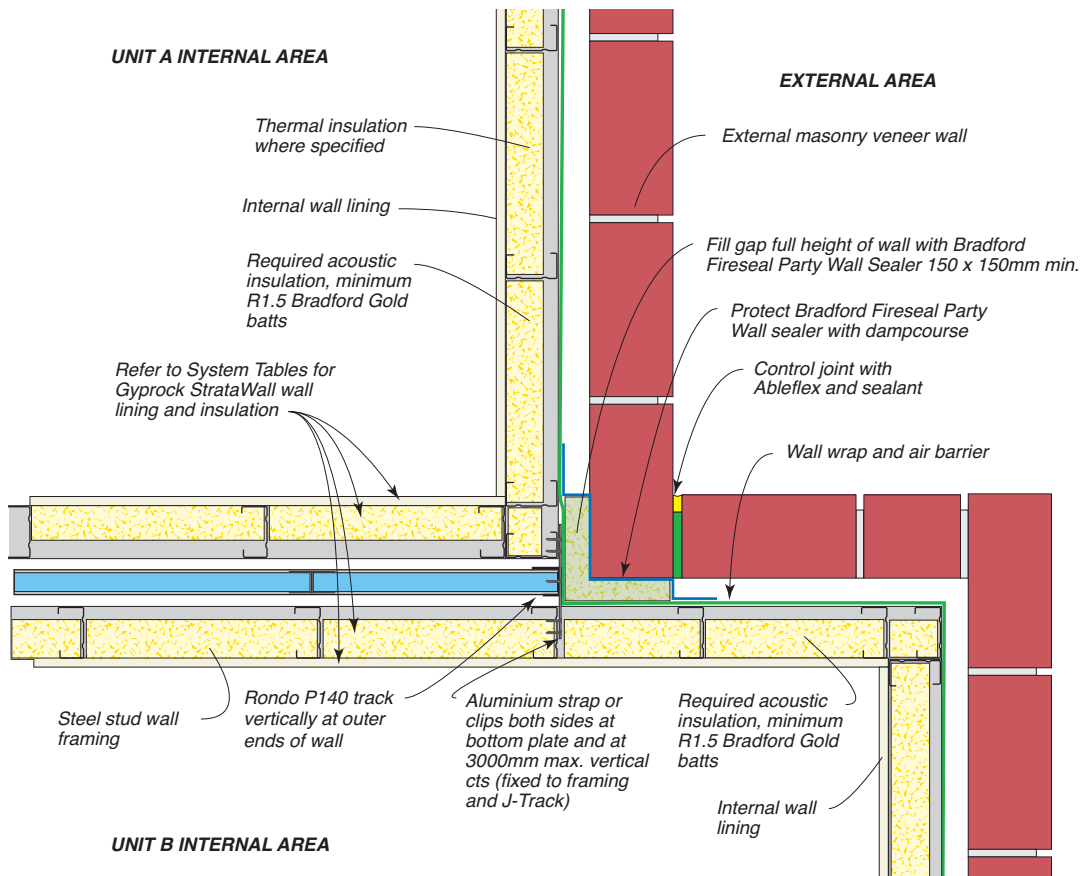

Figure 39: Junction of StrataWall and External Wall with Brick Veneer at Wall Return



# StrataWall Installation Checklist

Keep StrataWall system installation on track with this installation checklist, split by installation stage.

Date:
Builder:
Installer:
Project address:
StrataWall location:
CSR System Wall ID.:

Confirmed	Shaft Liner MP Panel and Framing Installation	Action Required
	Shaft Liner MP panels are installed below 3300mm in height.	
	H-Studs have been used for vertical framing between each of the Shaft Liner MP panels.	
	Shaft Liner MP panels have been installed in a vertical orientation.	
	Shaft Liner MP panels maintain a 15mm gap to the slab above.	
	Base steel angle has been fixed to slab at 600mm maximum centres with RONDO Cert-R-Fix fasteners or approved equivalent fixing commencing 150mm maximum from wall ends.	
	J-Track Extended Leg has been fixed to slab at 600mm maximum centres with RONDO Cert-R-Fix fasteners or approved equivalent fixing commencing 150mm maximum from wall ends.	
	Gyprock Fire Mastic or CSR FireSeal is installed to seal all gaps to specified base and top tracks where slab is uneven.	
	The Shaft Liner MP panels are not damaged.	

Confirmed	Wall Cavity	Action Required
	The cavity on both sides of the StrataWall, between wall framing and the central Shaft Liner MP Panel is 20-40mm.	
	CSR Bradford Insulation installed as per CSR System.	

Confirmed	Wall Framing	Action Required
	Head noggling track installed maximum 100mm from slab soffit.	
	Frame tracks have been fixed to slab at 600mm maximum centres with RONDO Cert-R-Fix fasteners or approved equivalent fixing to manufacturer's specifications.	

Confirmed	Service Penetrations	Action Required
	There are NO service penetrations through the Shaft Liner MP panels.	
	Only approved service penetration have been installed as shown in this guide.	

Confirmed	Wall Frame Sheeting	Action Required
	CSR Gyprock lining board installed as per CSR system.	
	CSR Gyprock linings maintain a 6mm to 20mm gap to the slab above.	
	Appropriate sealant is installed to seal all gaps from top of plasterboard to slab soffit.	

All items have been completed satisfactorily and to the acceptable standard for the following contractor:

Company Name:	
Installer Name:	
Signature:	
Date:	

## Health & Safety

Information on any known health risks of our products and how to handle them safely is on their package and/or the documentation accompanying them.

Additional information is listed in the Safety Data sheet. To obtain a copy, telephone 1300 306 556 or visit [www.gyprock.com.au](http://www.gyprock.com.au).

## Warranty

Gyprock products are designed to achieve optimal performance when part of a CSR integrated system.

CSR Building Products Limited warrants its Australian made Gyprock products to remain free of defects in material and manufacture for the usual lifetime of the product (25 years).

CSR warrants its International Alliance Gyprock products to remain free of defects in material and manufacture for 7 years.

For details on our product warranty, please visit [www.gyprock.com.au](http://www.gyprock.com.au), or contact us on 1300 306 556.

## Contact Details

### CSR Gyprock

[www.gyprock.com.au](http://www.gyprock.com.au)  
Telephone: 1300 306 556

### CSR DesignLINK Technical Support Service

Telephone: 1800 621 117  
Email: [designlink@csr.com.au](mailto:designlink@csr.com.au)

### New South Wales and ACT

376 Victoria Street,  
Wetherill Park NSW 2164

### Queensland

768 Boundary Road,  
Coopers Plains QLD 4108

### Victoria

277 Whitehall Street,  
Yarraville VIC 3013

### South Australia

Lot 100 Sharp Court,  
Mawson Lakes SA 5095

### Western Australia

19 Sheffield Road,  
Welshpool WA 6106

### Tasmania

PO Box 61,  
Glenorchy TAS 7010

### Northern Territory

Cnr Stuart Hwy & Angliss St,  
Berrimah NT 0828

# GYPROCK®

Triniti 3, 39 Delhi Road, North Ryde, NSW 2113, Australia  
CSR Building Products ABN 55 008 631 356



GYP949 OCTOBER 2023 (BMS1883.1023V2)

CSR Gyprock, CSR Building Products A.B.N. 55 008 631 356.  
The following are trade marks of CSR Limited and are under license. CSR, Gyprock®, Soundchek™, Aquachek™, Impactchek™, Superchek™, Fyrchek™, ECO8™, Supaceil™, Bradford™, Martini™, DesignLINK™, Himmel™.  
© CSR Limited 2023. Except as provided by the Copyright Act of 1968, no part of this publication may be reproduced in any form or by any means without the prior written permission of CSR Limited.